

STARLINE WINDOWS

NON-STRUCTURAL HEAD FLASHING
c/w END DAM AS PER BCBC
(NOT SUPPLIED BY STARLINE)

EXTERIOR
FINISH

3/8" MIN.

ALLOWANCE
FOR HEAD
DEFLECTION

#10 x 1-1/2" SHEET METAL SCREW EVERY 4'
ALONG SLIDER TRACK.
(NOT SUPPLIED BY STARLINE). 3/8" CAP
(SUPPLIED BY STARLINE)

ALUMINUM OR GALVANIZED STEEL
HEAD RETAINER, GA. AND SPACING
ARE PROJECT SPECIFIC.

2 1/2" GALVANIZED ROOFING
NAIL OR #10 x 1-1/2"
PANCAKE HEAD DT2000 SHEET
METAL SCREW
(NOT SUPPLIED BY STARLINE).
SPACING IS PROJECT SPECIFIC.

ALL FASTENING & METHODS SHOWN ARE
FOR EXAMPLE ONLY, AND ARE SUBJECT
TO PROJECT SPECIFIC REQUIREMENTS.

INSTALL WINDOW PRODUCTS IN ACCORDANCE
WITH THE CAN/CSA A440.4-07 (R2016) WINDOW,
DOOR AND SKYLIGHT INSTALLATION STANDARD.

13/32"
CLEARANCE

ROUGH OPENING
HEEL DIMENSION

4 1/2"

OPTIONAL INSECT SCREEN
(SUPPLIED BY STARLINE)

DOOR CONFIGURATION

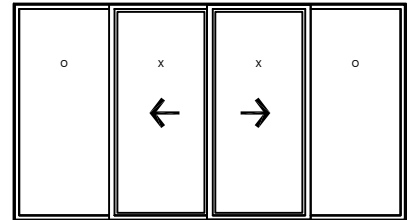

5/16"x1/16"
DRAINAGE HOLES @
1 7/8" FROM EACH END

NW7061

3/8"x1/4" DRAIN
SLOTS 2" IN FROM
JAMBS

DRAIN

NW-7011

2 TYPICAL SLIDING DOOR SILL AS SHOWN

NO.10 x 3/4" WAFER HEAD
TEK SCREW @ 6" O.C.
(NOT SUPPLIED BY STARLINE)

CONTINUOUS 1" x 1" x 1/16" ALUM.
ANCHORING ANGLE w/ ϕ 1/4"
PRE-DRILLED HOLES LOCATED AT THE
ATTACHMENT LEG FOR THE SUBSTRATE
(NOT SUPPLIED BY STARLINE)

#10 x 1-1/2" SHEET METAL
SCREW @ 12" O.C.
(NOT SUPPLIED BY STARLINE)

2" WIDE HIGH IMPACT PLASTIC SHIM @
4" O.C., TO PROVIDE 50% SUPPORT OF
WINDOW SILL.
(NOT SUPPLIED BY STARLINE)

3/8"
CLEARANCE

SET TRIM BOARD/SUPPORT
FOR HUMAN LOAD
(NOT SUPPLIED BY STARLINE)

3/8" X 5/8" FACTORY DRILLED
WEEP SLOTS @ 30" O.C. & 8"
FROM END
(OPTIONAL - MUST REQUEST WHEN
ORDERING)

DRAINAGE

3 3/8"

STARLINE'S
RECOMMENDED
INSTALLATION METHOD

NOTE: STRUCTURAL FASTENING DETAILS DO NOT SUPERCEDE SHOP DRAWINGS AND ARE TO BE USED AS A GENERAL GUIDELINE ONLY. WHERE INTENDED INSTALLATION METHOD IS SIGNIFICANTLY DIFFERENT, PLEASE CONTACT STARLINE BEFORE YOU BEGIN WORK. SCREWS, INSTALLATION ANGLES, SHIMS ETC. ARE NOT SUPPLIED BY STARLINE UNLESS OTHERWISE STATED IN CONTRACT DOCUMENTS.

STARLINE WINDOWS

Sliding Patio Door Installation Instructions

CONFIGURATION OF -OX,XO,OXO,OXXO

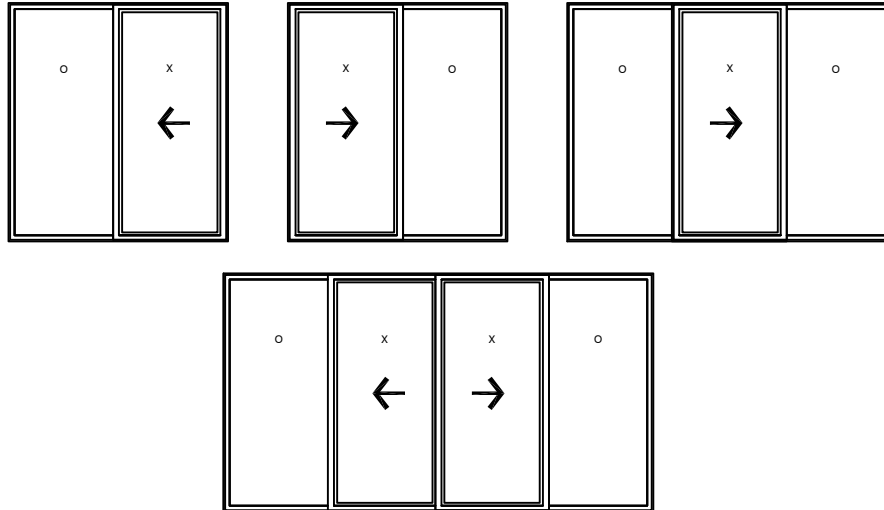

INSTALLATION OF MAINFRAME -OX,XO,OXO,OXXO

- * Ensure door is installed level, square and plumb.
- * Measure diagonal to check squareness.
- * Reference Starline banner for balance of recommended door installation instructions. (i.e shimming)
- * Reference page 4 and 5 for specific configuration installation instructions.
- * On jambs fasten using roofing nails NOT screws.
- * Use head retainer clips for the head of the door, do not put any nails or screws through the top nailing flange.

INSTALLATION OF SLIDERS (shipped uninstalled) - OXXO

- * Secondary slider comes from factory w/astragal already attached.
- * Remove 2 screws securing E - latch strike plate. Then remove plate.
- * Remove 3/8" screw caps from astragal.
- * Locate screws fastening meeting rail to secondary slider and loosen all screws by one turn (do not completely remove screws, only loosen them).
- * Meeting rail should now slide freely on secondary slider.
- * Insert head of secondary slider into slider pocket at head of door.
- * While simultaneously lifting meeting rail up, pivot bottom of slider into bottom slider pocket.
- * Adjust slider wheels of primary & secondary sliders until optimum location is achieved (centered vertically on door).
- * Relocate meeting rail fastening screws and ensure they are roughly centered in 3/8" access hole. If they are, then tighten all screws and reinsert 3/8" caps.
- * Reinstall strike plate and adjust in conjunction with lock/latch.

INSTALLATION OF SCREEN DOOR

- * Install both screen doors by first inserting into header screen pocket (screen with meeting rail should be on right side).
- * To assist in the install, you may use a putty knife to retract and lift the lower wheel assembly over the screen track pocket.
- * Once installed adjust accordingly. Adjustment screws are located on the side /bottom of screen door.
- * Once the door is adjusted, top wheels should be adjusted with light tension to avoid rocking.

STARLINE WINDOWS

8500 SERIES ADJUSTMENTS

1. WHEEL ASSEMBLY ADJUSTMENTS

- * Use a #2 Phillips or #2 Robertson screwdriver to turn adjustment screw.
- * To raise panel, turn wheel adjustment screw clockwise.
- * To lower panel, turn wheel adjustment screw counter-clockwise.
- * Adjust panels to maintain even sightline.
- * Raise panel enough so that the foot lock doesn't bottom out and door panel slides freely on track and is square to the jamb. Optimally, panel should be centered vertically.

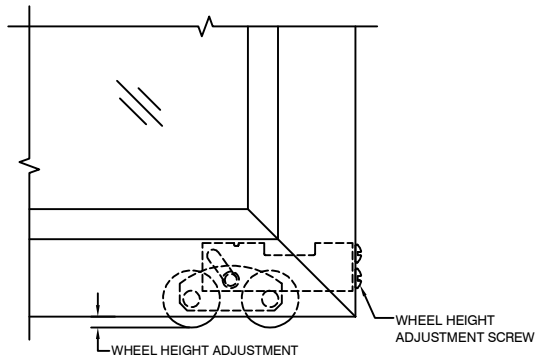

FRONT VIEW

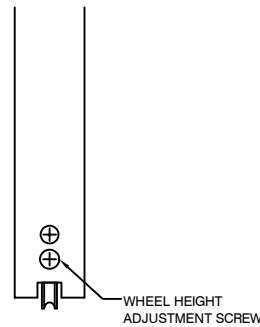

EDGE VIEW #1

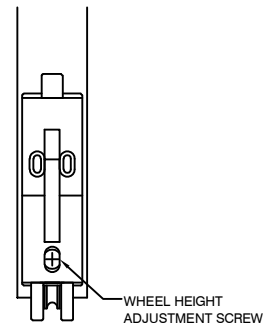

EDGE VIEW #2
WITH FOOT LOCK

2. STRIKE PLATE AND LOCK ADJUSTMENTS

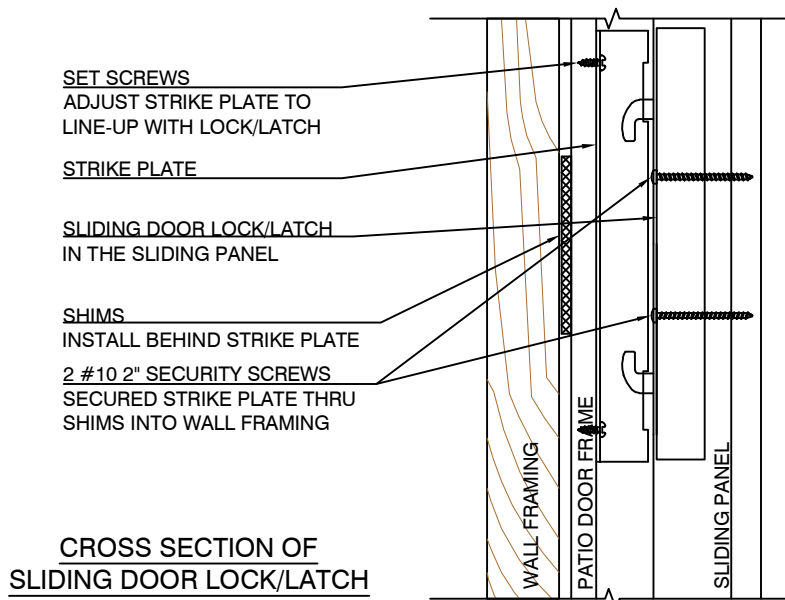

CROSS SECTION OF
SLIDING DOOR LOCK/LATCH

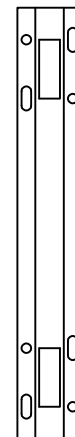

E Latch Strike Plate

FOR CONTINUED HIGH PERFORMANCE - KEEP TRACK CLEAN OF ANY DEBRIS.
USE A MILD SOAP AND WARM WATER SOLUTION FOR CLEANING. AVOID USING
ABRASIVE CLEANERS OR MATERIALS.

STARLINE WINDOWS

NON-STRUCTURAL HEAD FLASHING
c/w END DAM AS PER BCBC
(NOT SUPPLIED BY STARLINE)

EXTERIOR
FINISH

3/8" MIN.

ALLOWANCE
FOR HEAD
DEFLECTION

ALUMINUM OR GALVANIZED STEEL
HEAD RETAINER, GA. AND SPACING
ARE PROJECT SPECIFIC.

2 1/2" GALVANIZED ROOFING
NAIL OR #10 x 1-1/2"
PANCAKE HEAD DT2000 SHEET
METAL SCREW
(NOT SUPPLIED BY STARLINE)
SPACING IS PROJECT SPECIFIC.

ALL FASTENING & METHODS SHOWN ARE
FOR EXAMPLE ONLY, AND ARE SUBJECT
TO PROJECT SPECIFIC REQUIREMENTS.

INSTALL WINDOW PRODUCTS IN ACCORDANCE
WITH THE CAN/CSA A440.4-07 (R2016) WINDOW,
DOOR AND SKYLIGHT INSTALLATION STANDARD.

1 TYPICAL SLIDING DOOR
HEAD AS SHOWN

DOOR CONFIGURATION

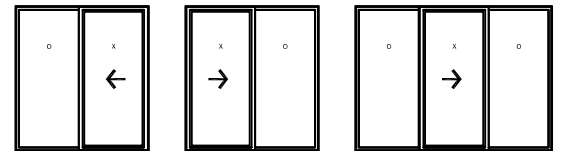

ROUGH OPENING
HEEL DIMENSION

13/32"
CLEARANCE

4 1/2"

OPTIONAL INSECT SCREEN
(SUPPLIED BY STARLINE)

5/16"x1/16"
DRAINAGE HOLES @
1/8" FROM EACH END

NW7061

2 TYPICAL SLIDING DOOR
SILL AS SHOWN

3/8"x1/4" DRAIN
SLOTS 2" IN FROM
JAMBS

DRAIN

NW-7011

NO.10 x 3/4" WAFER HEAD
TEK SCREW @ 6" O.C.
(NOT SUPPLIED BY STARLINE)

CONTINUOUS 1" x 1" x 1/16" ALUM.
ANCHORING ANGLE w/ ϕ 1/4"
PRE-DRILLED HOLES LOCATED AT THE
ATTACHMENT LEG FOR THE SUBSTRATE
(NOT SUPPLIED BY STARLINE)

#10 x 1-1/2" SHEET METAL
SCREW @ 12" O.C.
(NOT SUPPLIED BY STARLINE)

2" WIDE HIGH IMPACT PLASTIC SHIM @
4" O.C., TO PROVIDE 50% SUPPORT OF
WINDOW SILL.
(NOT SUPPLIED BY STARLINE)

3/8"
CLEARANCE

SET TRIM BOARD/SUPPORT
FOR HUMAN LOAD
(NOT SUPPLIED BY STARLINE)

3/8" X 5/8" FACTORY DRILLED
WEEP SLOTS @ 30" O.C. & 8"
FROM END
(OPTIONAL - MUST REQUEST WHEN
ORDERING)

DRAINAGE

3 3/8"

STARLINE'S
RECOMMENDED
INSTALLATION METHOD

NOTE: STRUCTURAL FASTENING DETAILS DO NOT SUPERCEDE SHOP DRAWINGS AND ARE TO BE USED AS A GENERAL GUIDELINE ONLY. WHERE INTENDED INSTALLATION METHOD IS SIGNIFICANTLY DIFFERENT, PLEASE CONTACT STARLINE BEFORE YOU BEGIN WORK. SCREWS, INSTALLATION ANGLES, SHIMS ETC. ARE NOT SUPPLIED BY STARLINE UNLESS OTHERWISE STATED IN CONTRACT DOCUMENTS.