

STARLINE
WINDOWS

Series 9506 Product Renderings
Aluminum Outswing Balcony Door
Available in Double & Triple Glazed

Quality, Comfort & Peace of Mind

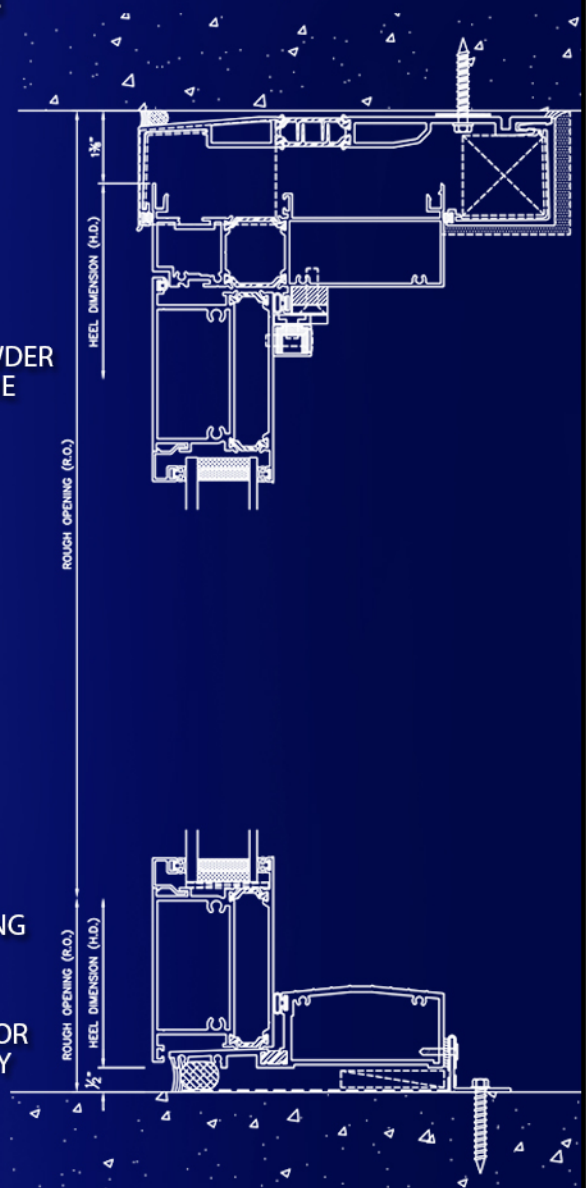
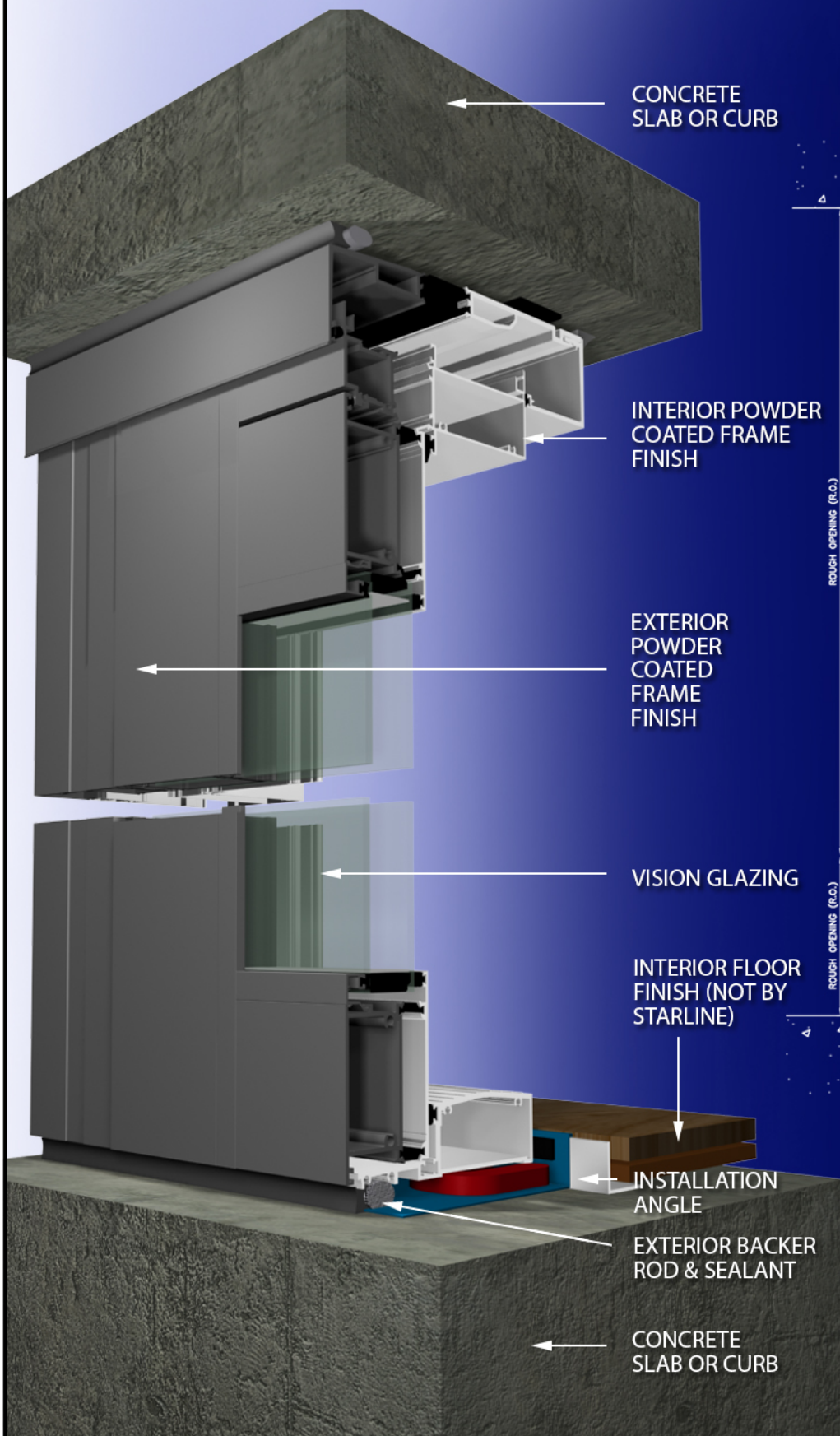

SERIES 9506 - HEAD DEFLECTOR & SILL

THIS DETAIL IS A SUGGESTED METHOD OF INSTALLATION AND DOES NOT REPRESENT A DETAIL THAT IS SUITABLE FOR A SPECIFIC PROJECT. TO CONFIRM PROJECT SPECIFIC DETAILS, PLEASE CHECK WITH YOUR WATERPROOFING/BUILDING ENVELOPE CONSULTANT.

DRAWINGS ARE SUBJECT TO CHANGE WITHOUT NOTICE

AUTHOR:

S.R.R.

DATE:

JULY 2020

DWG NO:

9506 - DWG 1

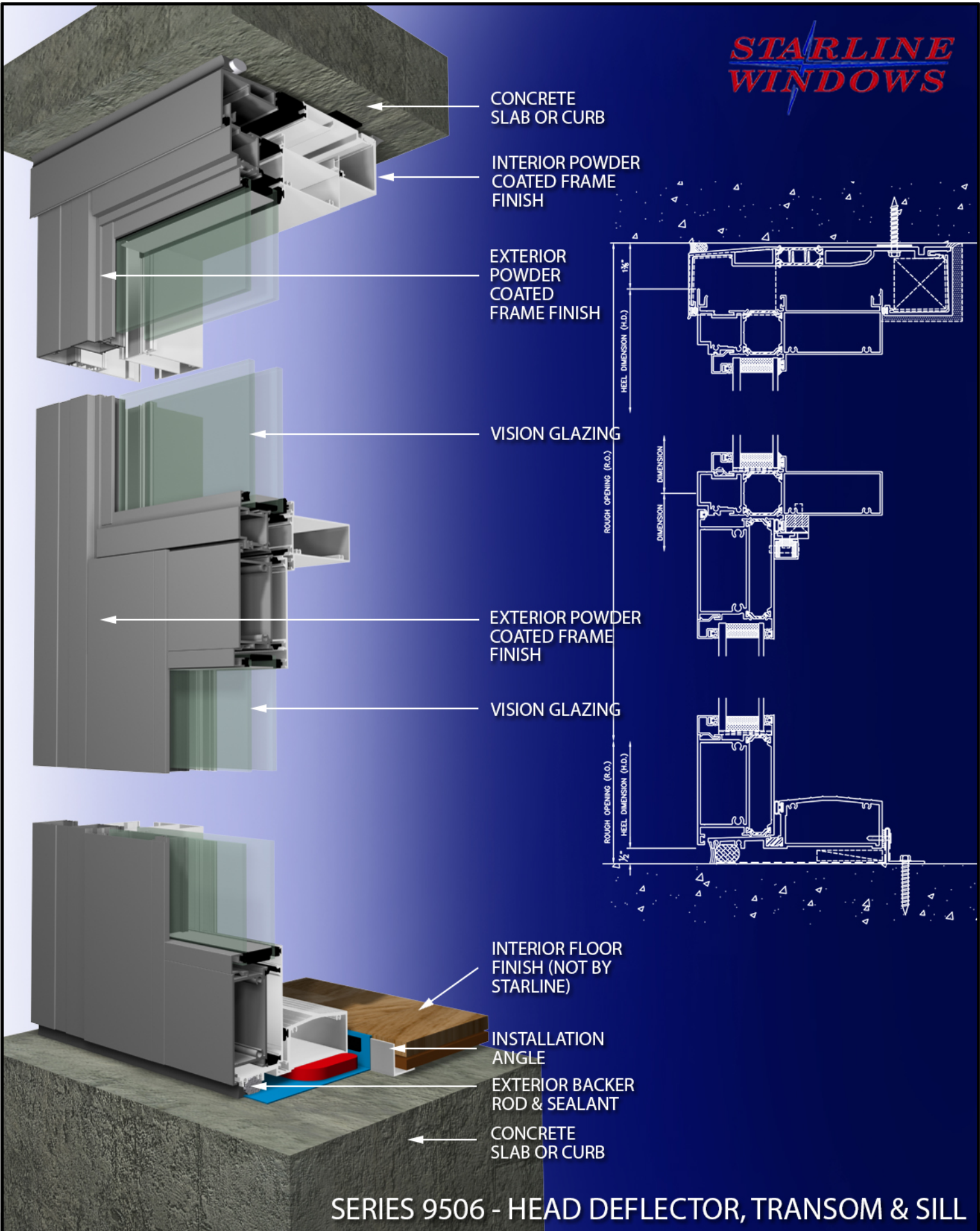

THIS DETAIL IS A SUGGESTED METHOD OF INSTALLATION AND DOES NOT REPRESENT A DETAIL THAT IS SUITABLE FOR A SPECIFIC PROJECT. TO CONFIRM PROJECT SPECIFIC DETAILS, PLEASE CHECK WITH YOUR WATERPROOFING/BUILDING ENVELOPE CONSULTANT.

DRAWINGS ARE SUBJECT TO CHANGE WITHOUT NOTICE

AUTHOR:	DATE:	DWG NO:
S.R.R.	JULY 2020	9506 - DWG 2

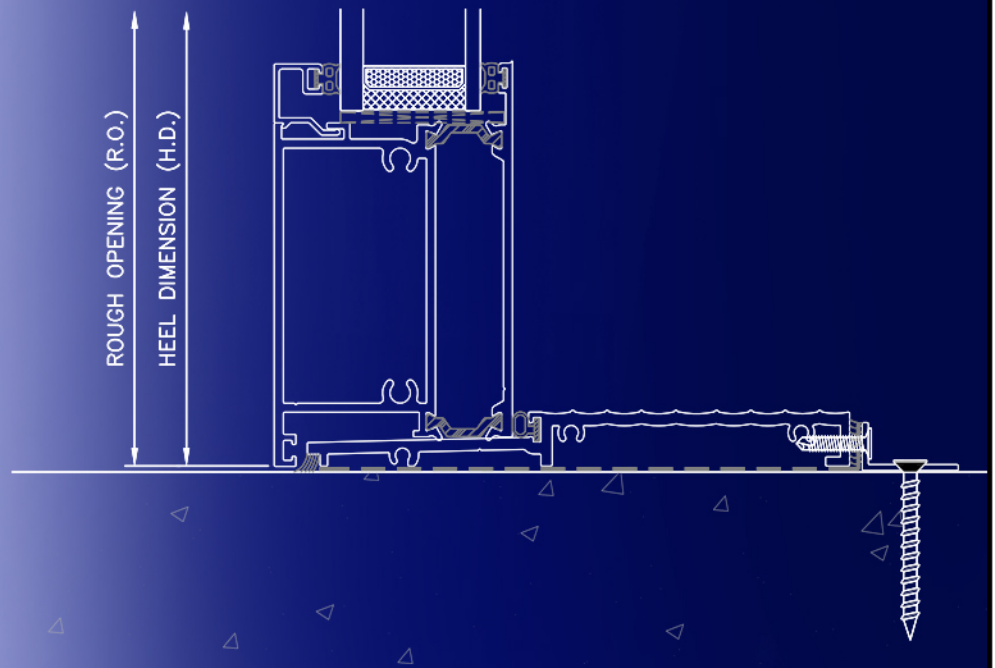
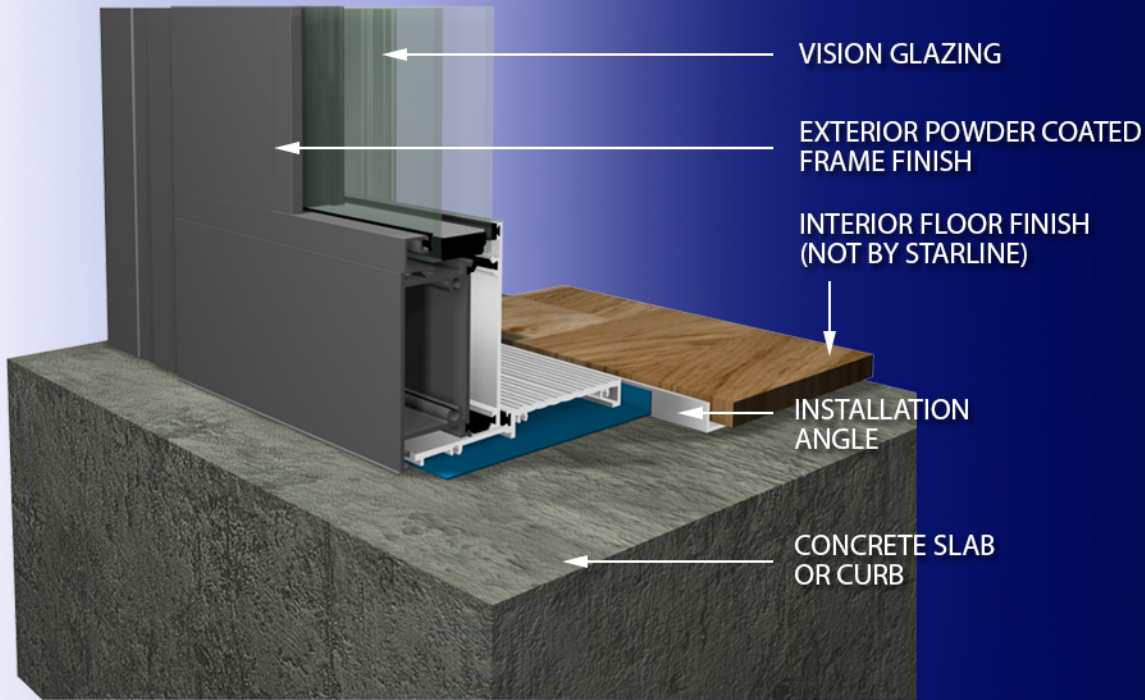

SERIES 9506 - ACCESSIBLE (ADA) THRESHOLD

THIS DETAIL IS A SUGGESTED METHOD OF INSTALLATION AND DOES NOT REPRESENT A DETAIL THAT IS SUITABLE FOR A SPECIFIC PROJECT. TO CONFIRM PROJECT SPECIFIC DETAILS, PLEASE CHECK WITH YOUR WATERPROOFING/BUILDING ENVELOPE CONSULTANT.

DRAWINGS ARE SUBJECT TO CHANGE WITHOUT NOTICE

AUTHOR:

S.R.R.

DATE:

JULY 2020

DWG NO:

9506 - DWG 3

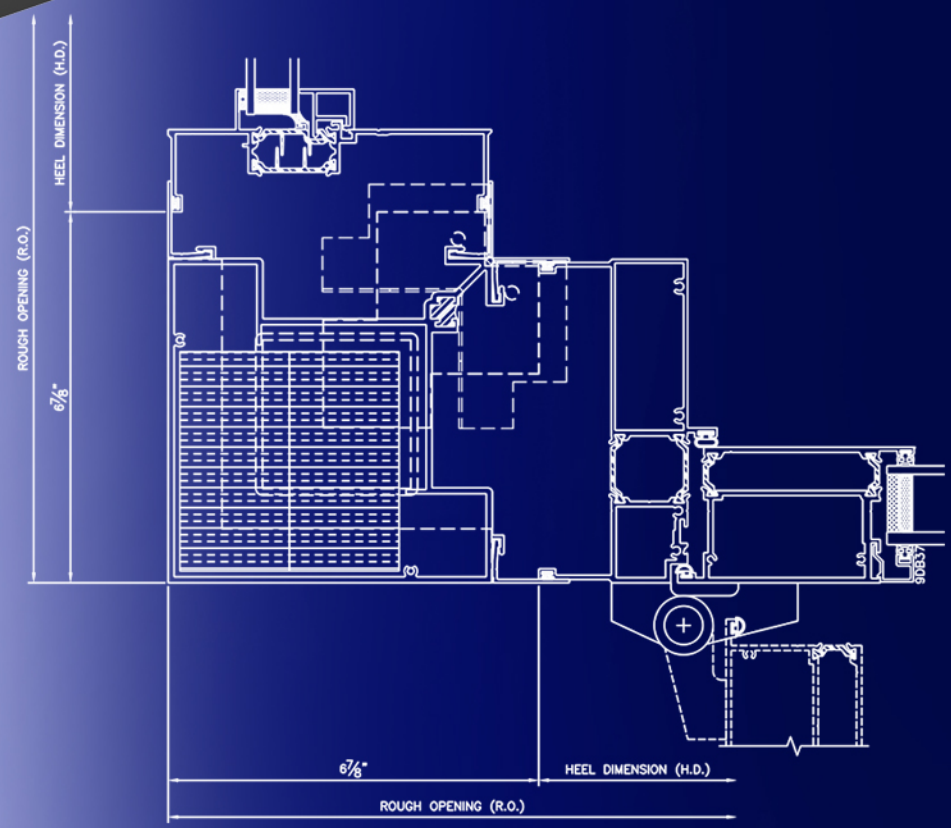
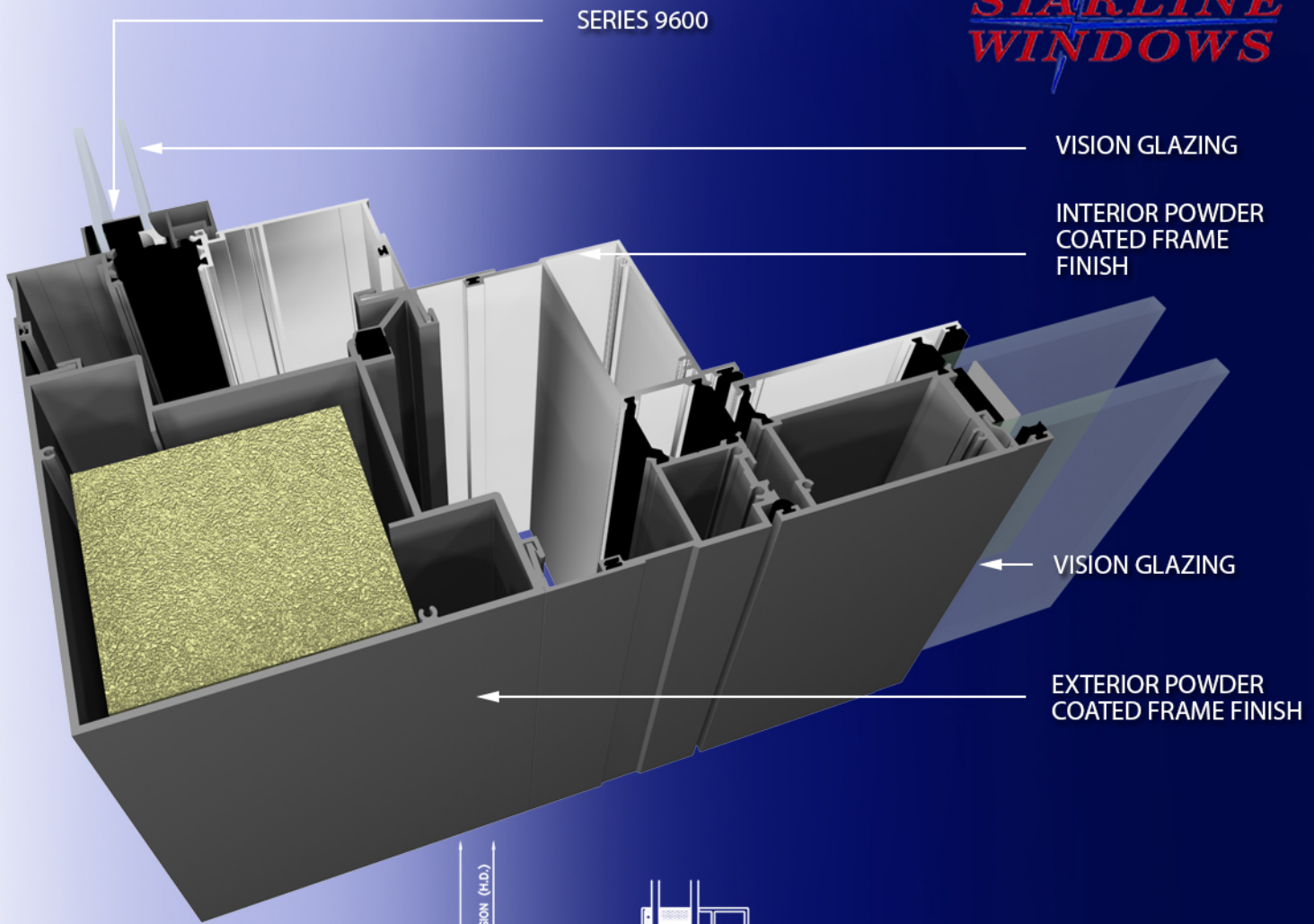

SERIES 9506 - 90 DEGREE SEISMIC CORNER COUPLER

THIS DETAIL IS A SUGGESTED METHOD OF INSTALLATION AND DOES NOT REPRESENT A DETAIL THAT IS SUITABLE FOR A SPECIFIC PROJECT. TO CONFIRM PROJECT SPECIFIC DETAILS, PLEASE CHECK WITH YOUR WATERPROOFING/BUILDING ENVELOPE CONSULTANT.

DRAWINGS ARE SUBJECT TO CHANGE WITHOUT NOTICE

AUTHOR:	DATE:	DWG NO:
S.R.R.	JULY 2020	9506 - DWG 4

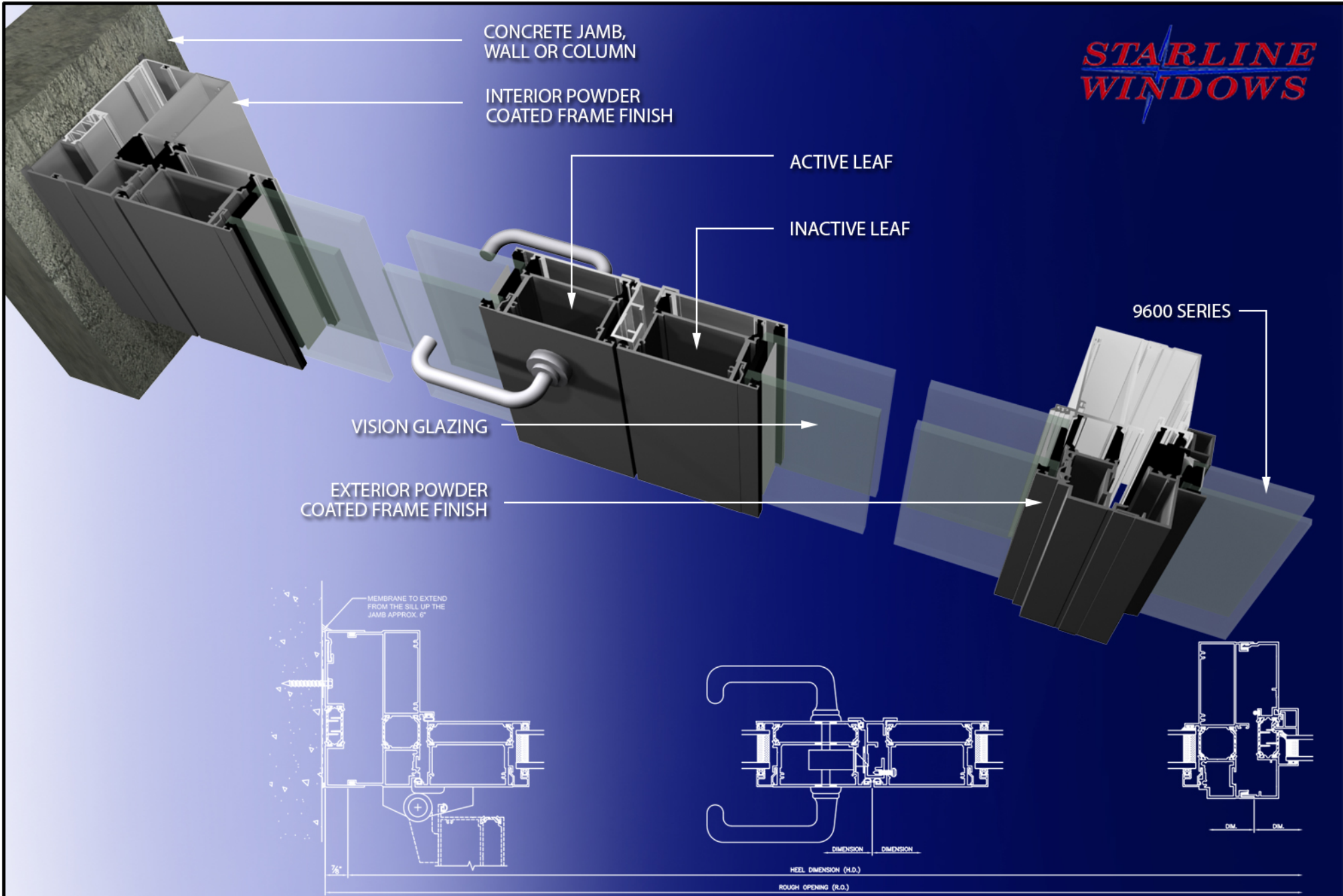

SERIES 9506 - FRENCH DOOR - SEISMIC JAMB, ASTRAGAL & 180 DEGREE COUPLER

THIS DETAIL IS A SUGGESTED METHOD OF INSTALLATION AND DOES NOT REPRESENT A DETAIL THAT IS SUITABLE FOR A SPECIFIC PROJECT. TO CONFIRM PROJECT SPECIFIC DETAILS, PLEASE CHECK WITH YOUR WATERPROOFING/BUILDING ENVELOPE CONSULTANT.

DRAWINGS ARE SUBJECT TO CHANGE WITHOUT NOTICE

AUTHOR:	DATE:	DRAWING NUMBER:
S.R.R.	JULY 2020	9506 - DWG 5