

Series 9000 Product Catalogue

Aluminum Window Wall
Available in Double Glazed

STARLINE
WINDOWS

Quality, Comfort & Peace of Mind



Foreword

This Design Guide provides design guidelines, manufacturing capabilities and specifications on the Series 9000 Aluminum Window Wall available with fixed windows, casements, awnings, and various opaque options. The 9000 is available in double glazing.

This document is intended to provide information on our standard products. Non-standard designs and applications can be reviewed to determine the feasibility on a project-specific basis.

Please email any project specific enquiries to technical@starlinewindows.com or architectural@starlinewindows.com.

This document subject to change without notice.

Starline Windows reserves the right to change or discontinue this product without notice.

www.starlinewindows.com

© 2023-12-08 Starline Windows

Table of Contents

Foreword	2
Recommended Size Guidelines	7
New Construction Project Maximums	7
Renovation Project Maximums	7
Diameter for Radius Windows	8
Maximum Length of Vertical Coupler and Horizontal T-bar.....	8
Crippled Mullions.....	8
Minimum Vent Size	9
Maximum Vent Size	10
Determining Vent Size Using Charts	10
Calculating Fixed, Combination, and Vent Window Sizes.....	11
Using Starline Calculator.....	11
Using Manual Calculations.....	12
Maximum IGU Area Based on Glass Lite Thickness ^{1,2}	12
Fixed Window	13
Awning (no 4" restrictor).....	13
Awning (4" restrictor).....	13
Casement	14
Combination Window	14
Egress Hinge Chart	15
Egress 60° Hinge Chart	16
Window Hardware	17
Handles.....	17
Vent Sizes with 1 or 2 Cam Handles	17
Options	17
Standard Interior Cam Handle.....	18
Mounted Keeper for Standard Interior Handle	18
Multi-Point Locking Hardware	18
Head Trickle Vents.....	19
Window Head Trickle Vent with Exterior Grill & Interior Vent.....	19
Insulation	19

Bypass Guidelines and Options	20
Maximum Bypass Height, Weight, and required Nominal Supported Area	20
Exterior and Interior Material for Bypass and other Opaque Areas.....	21
Insulation at the Slab Edge	23
In-Slab Ducts	24
Transom Ducts.....	24
Electrical, Mechanical, and Other Penetrations	25
Setbacks Required for Columns and Shear walls	26
6” Deep Deflection Header.....	26
7” Deep Deflection Header.....	27
Stage Anchors	28
Grilles	29
Climb Deterrents	29
Finishes (Powder Coating)	30
Options	30
Colour Options.....	30
Glazing	31
Maximum Area of IGU.....	31
Aspect Ratio of Glass.....	32
IGU Chart	32
Acoustical Ratings Based on 23mm Double Glazed IGU	33
Performance Test Results	33
Canada	33
USA	33
Clear Opening Height Point of Measurement	34
Egress Hinge Clear Opening Diagrams	36
Clear Openings Between Seismic Jambs.....	36
Clear Openings Between Seismic Jamb and Coupler	37
Clear Openings Between Couplers	38
60° Hinge Clear Opening Diagrams	39
Clear Openings Between Seismic Jambs.....	39
Clear Openings Between Seismic Jamb and Coupler	40
Clear Openings Between Couplers	41
Product Specification 08 46 13 – Glazed Aluminum Window Wall	42

Series 9000 Aluminum Window Wall Design Guidelines

Part 1 - General.....	42
1.1 Summary	42
1.2 Quality Assurance.....	43
1.3 Structural requirements.....	43
1.4 Test and Performance Requirements.....	43
1.5 Submittals	45
1.6 Project Conditions.....	45
Part 2 – Products	46
2.1 Manufacturers	46
2.2 Material	46
2.3 Fabrication	46
2.4 Glazing ¹	47
2.5 Hardware ¹	47
2.6 Finishes (Powder Coating)	48
2.7 Optional Items.....	49
Part 3 - Execution.....	51
3.1 Examination	51
3.2 Installation.....	51
3.3 Field Quality and Control.....	51
3.4 Protection and Cleaning	51
Series 9000 NFRC Product Energy Chart	52

This page left blank.

Series 9000 Aluminum Window Wall Design Guidelines



Recommended Size Guidelines

Starline Windows provides maximum guidelines for window module area and weight for new construction and restoration projects.

Window wall comfortably spans 11' tall.

Starline will often use the series 9600 (6" deep system) in lieu of CW for limited scopes when the floor spans require it. (I.e., more than 11' to an 18' tall maximum span). This is regularly done on projects at amenity locations or feature floors with taller floor to floor heights (I.e., Amenity and Penthouse locations).

Note: Spans taller than 11' need to be reviewed on a project specific basis to determine the maximum allowable span.

New Construction Project Maximums

FINISHES (POWDER COAT)	MAXIMUM WEIGHT (POUNDS)	MAXIMUM AREA (SQ FT)
Meets AAMA 2603 and 2604 Specification	240	45
Meets AAMA 2605 Specification	220	43

Example: At a 9'-8" floor to floor span, the maximum width for the window wall module can be 4'-6".

Renovation Project Maximums

FINISHES (POWDER COAT)	MAXIMUM WEIGHT (POUNDS)	MAXIMUM AREA (SQ FT)
Meets AAMA 2603 and 2604 Specification	220	43
Meets AAMA 2605 Specification	200	40

Example: At a 9'-8" floor to floor span, the maximum width for the window wall module can be 4'-2".

Note:

- Limitations are guidelines and depend on site conditions.
- Horizontal coupling is not available.

For instructions and examples on how to calculate area and weight, refer to [Calculate Fixed, Combination, and Vent Window Size and Weight](#).

Diameter for Radius Windows

Starline Windows offers radius fixed windows.

Radius casements, awnings and deflection channels are not available.

The minimum diameter for a radius fixed window is 36" and the maximum diameter is 72".

Maximum Length of Vertical Coupler and Horizontal T-bar

Maximum span for a horizontal T-bar without a vertical coupler is 72".

Maximum span for a vertical coupler without the use of a horizontal T-bar is 84". This span may be able to increase to 96", with the use of an I-coupler in lieu of Starline's standard coupler.

The use of the I-coupler will be considered on a project specific basis.

For an image and further details, refer to [Maximum Area of IGU](#).

Crippled Mullions

Starline cannot manufacture windows and doors with crippled mullions/couplers. All vertical mullions/couplers and horizontal mullions within a window or door module must run full height and width of the window or door module.

VERTICAL COUPLER MUST RUN THE FULL HEIGHT OF THE WINDOW, AS SHOWN IN IMAGE ON THE RIGHT

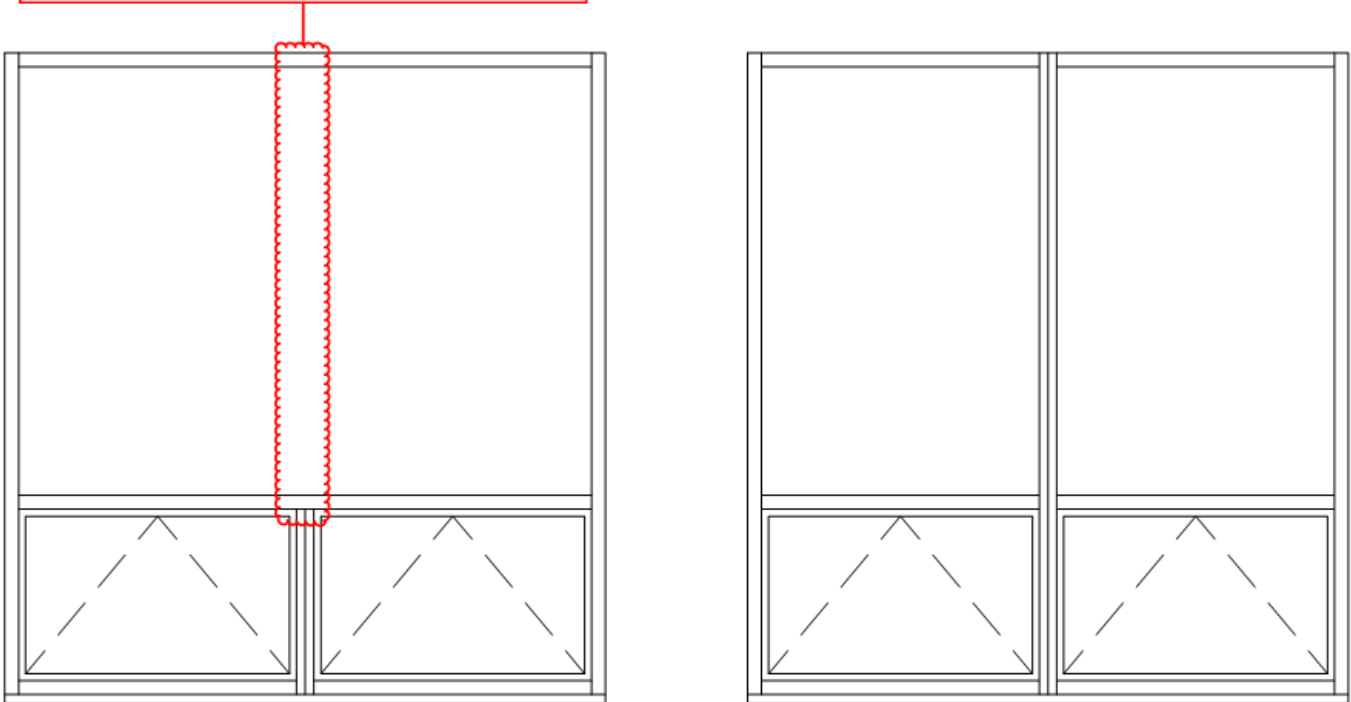

Series 9000 Aluminum Window Wall Design Guidelines



Minimum Vent Size

Sizes are based on heel to center dimensions

HARDWARE	OPERABLE VENT	WIDTH (In)	HEIGHT (In)
Cam Handle with 60° hinge with 4" restrictor	Awning	15"	15"
	Casement	15"	15"
Cam Handle with 90° egress hinge	Awning	15"	19"
	Casement	19"	15"
Cam Handle with 60° hinge with 4" mechanical restrictor	Awning	15"	22"
	Casement	22"	15"
Multi-point	Awning	22"	15"
	Casement	15"	22"

Note: It is Starline's standard to restrict all windows to 4" unless a non-restricted window is required for egress purposes.

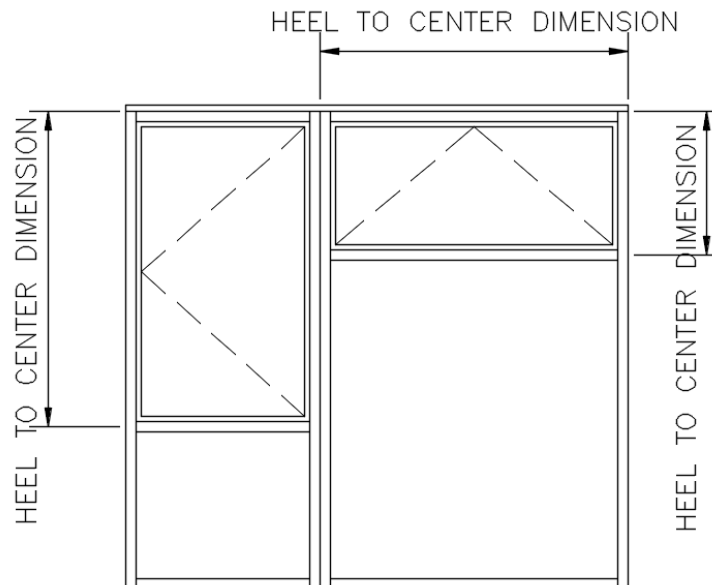

Maximum Vent Size

To design an operable vent that is within Starline's recommended maximum vent size, refer to the chart below:

OPERABLE VENT	MAX. WIDTH (In)	MAX. HEIGHT (In)	MAX. AREA (Sq.Ft.)	MAX. WEIGHT (Pounds)
AWNING	48	30	7.50	30
AWNING 4" - RESTRICTED	48	48	16.00	80
CASEMENT - RESTRICTED	30	60	10.00	50

Determining Vent Size Using Charts

Once the operable vent style and glass thickness have been determined, the following charts can be used to determine the maximum vent size allowed. It is not feasible to list all the various thickness of glass combinations in the charts.

After the charts there is a section called Determining Fixed, Combination, & Vent Window Size & Weight using Calculations which provides examples of how to perform manual calculations using any glass combination.

Recommended Maximum Sizes: Casement with Restrictor

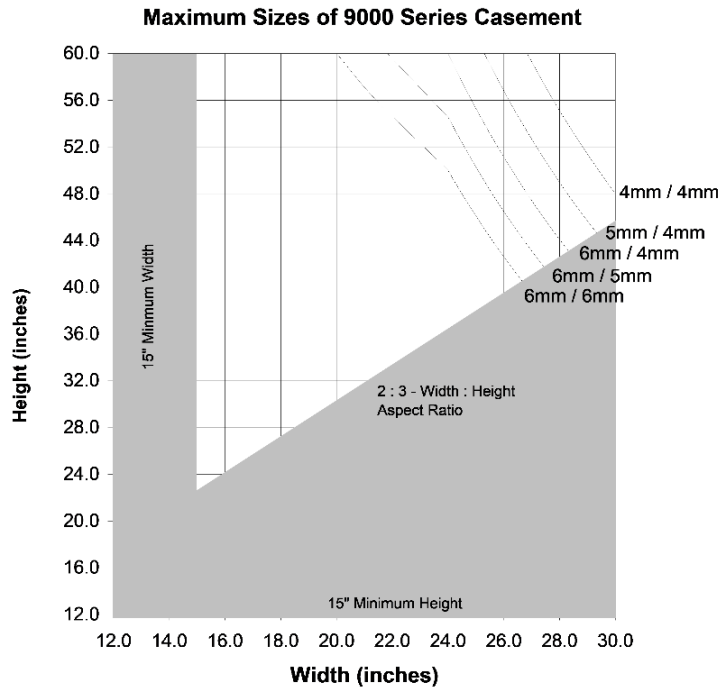

Torque Load (Guideline)

The maximum allowable torque load is 50 foot-pounds for 9000 casement windows.

To calculate the approximate torque load use the following formula:

$$\text{Torque Load} = \text{Area of casement [ft}^2\text{]} * \text{Weight of glass [pound/ft}^2\text{]} * \text{Width of casement [ft]} / ^2$$

$$\text{Area [ft}^2\text{]} = \text{width [ft]} \text{ of casement} * \text{height [ft]} \text{ of casement}$$

$$\text{Weight of glass [pound/ft}^2\text{]} = \text{Thickness of glass [mm]} * 0.512$$

Series 9000 Aluminum Window Wall Design Guidelines



Recommended Maximum Sizes: Awning with and without Restrictor

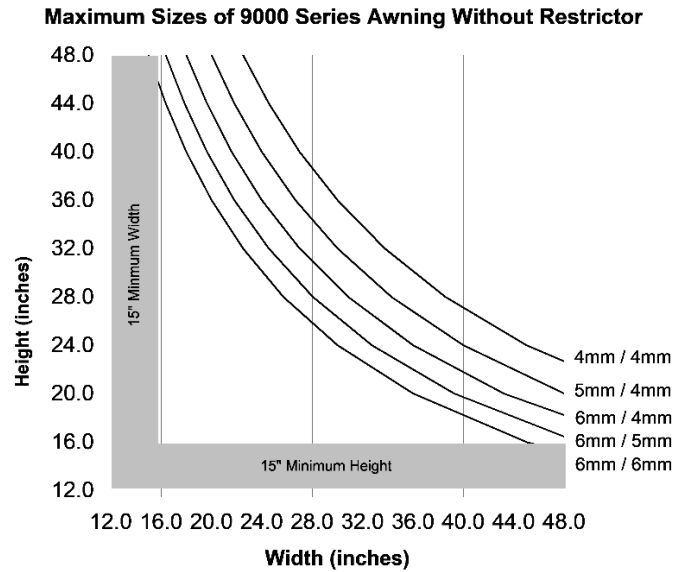
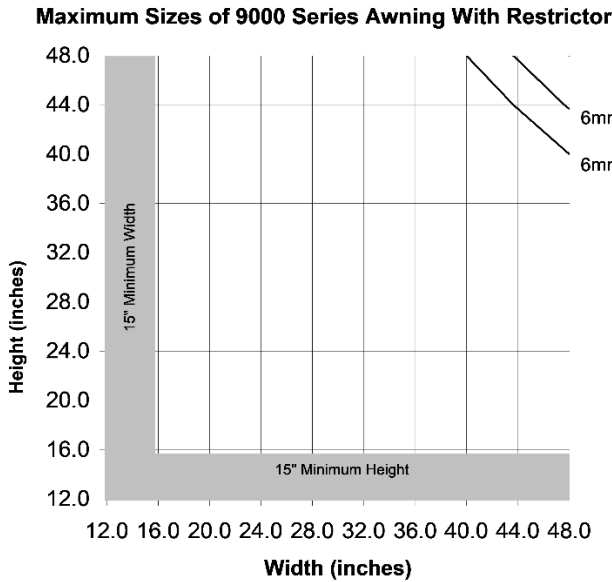

Calculating Fixed, Combination, and Vent Window Sizes

You can calculate window sizes using a calculator provided by Starline Windows or using your own calculations.

Using Starline Calculator

Starline has a maximum fixed, combination and vent window size calculator available for use.

The calculator states a PASS or FAIL for each criterion which is required to be met. A vent must pass the maximum width, height, area and weight guidelines. In the case of a casement, it also considers maximum torque load and width to height ratio. All of these criteria need to be satisfied; otherwise, the vent size needs to be reduced.

To obtain a copy of this calculator, contact technical@starlinewindows.com.

Note: This calculator is a tool to assist with the design of basic window configurations. Combination windows can be complicated and some configurations may need to be reviewed and approved by Starline's Designers and Structural Engineer for feasibility and structural compliance.

For any type of window; fixed, combination and/or vents, there may be certain design and/or structural requirements, building code requirements, by-law requirements, etc. which require consideration and could dictate the size of the window, glass thickness, etc. Final window sizes and configurations will be confirmed during the shop drawing phase, if applicable, and ordering of the windows.

Using Manual Calculations

Once the window configuration has been selected, along with the frame dimensions (width and height) and the glass thickness, a calculation can be performed to determine the area and weight of the window.

To calculate weight, add the glass weight based on your IGU glass thicknesses + 1 lb/ft² for the window wall framing.

Glass thickness can play a significant factor in determining how large the window can be. The thicker the glass, the heavier the IGU. When thicker glass is selected commonly the maximum weight allowed is reached prior to the maximum area allowed.

Refer to the **Typical Float Glass Weight per Thickness** chart below for weight of glass.

Typical Float Glass Weight per Thickness¹

GLASS LITE THICKNESS	4mm	5mm	6mm	8mm	10mm
Monolithic Glass – Weight (lb/ ft ²)	2.1	2.6	3.1	4.1	5.1
Double Glazed IGU – Weight (lb/ ft ²)	4.1	5.1	6.2	8.2	10.2
Triple Glazed IGU – Weight (lb/ ft ²)	6.2	7.7	9.2	12.3	15.4

Maximum IGU Area Based on Glass Lite Thickness^{1,2}

GLASS LITE THICKNESS	MAXIMUM IGU AREA		MAXIMUM WIDTH ³	MAXIMUM HEIGHT ⁴
	DOUBLE GLAZED	TRIPLE GLAZED		
4mm	30 sq. ft.	30 sq. ft.	72"	84"
5mm	40 sq. ft.	35 sq. ft.	72"	84"
6mm	40 sq. ft.	35 sq. ft.	72"	84"

Note: There are minimum and maximum dimensions as well as overall IGU areas to consider for different types of glass, such as annealed, tempered, laminated, spandrel, etc. Maximum dimensions are as laid out in the above chart, regardless of the glass type.

For all other sizing information please visit the Products tab on the Vitrum Glass Groups website at: <http://www.vitrum.ca/> for the most up to date information.

Note: The following calculations are intended to provide examples on how to calculate window sizes for basic window configurations.

Combination windows can be complicated and some configurations may need to be reviewed and approved by Starline's Designers and Structural Engineer for feasibility and structural compliance. A combination window is a window that has multiple lites; fixed and/or operable vents. These lites and vents are divided by T-Bar(s).

For any type of window; fixed, combination and vents, there may be certain design and /or structural requirements, building code requirements, by-law requirements, etc. that requires consideration and could dictate the size of the window, glass thickness, etc. Final window sizes and configurations will be confirmed during the shop drawing phase, if applicable, and ordering of the windows.

Series 9000 Aluminum Window Wall Design Guidelines



The following figure provides an example a combination window coupled to a fixed lite.

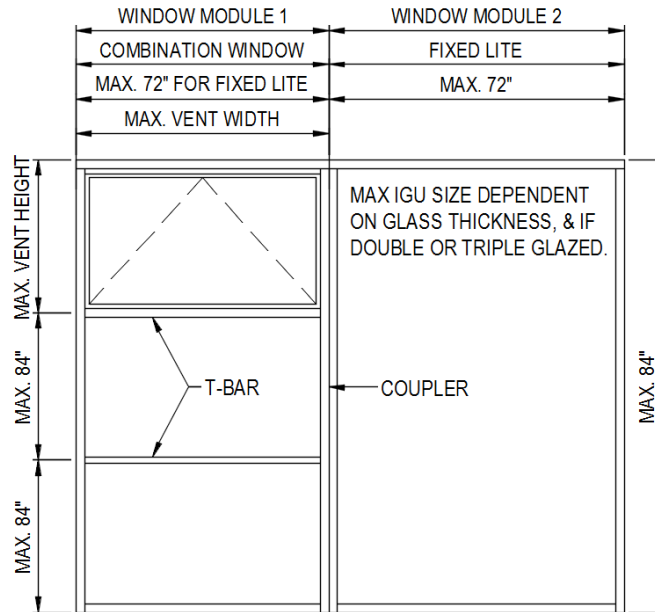

Note: The max. height of 84” for an IGU may be able to be increased using an I-coupler in lieu of a standard coupler. This can be reviewed on a project-specific basis.

The following examples are intended to provide sample calculations for the following window configurations:

Fixed Window

- | | | |
|--|--|---|
| 1. Determine fixed window size ^{1,2,3 4} | $(60" \times 84") / 144" = 35 \text{ ft}^2$ | ✓ |
| 2. Determine glass weight - Based on area, min. 5mm glass required - Double glazed - 5mm / Air / 5mm | $= 5.1 \text{ lbs/ft}^2$ | ✓ |
| 3. Calculate weight per square foot (add window framing 1 lbs/ft ²) | $5.1 \text{ lbs/ft}^2 + 1 \text{ lbs/ft}^2 = 6.1 \text{ lbs/ft}^2$ | ✓ |
| 4. Calculate overall weight | $35 \text{ ft}^2 \times 6.1 \text{ lbs/ft}^2 = 214 \text{ lbs}$ | ✓ |

Awning (no 4” restrictor)

- | | | |
|---|--|---|
| 1. Determine awning size - 30” wide x 24” tall. | $(30" \times 24") / 144" = 5 \text{ ft}^2$ | ✓ |
| 2. Determine glass weight - Double glazed - 4mm / Air / 4mm | $= 4.1 \text{ lbs/ft}^2$ | ✓ |
| 3. Calculate weight per square foot (add window framing 1 lbs/ft ²) | $4.1 \text{ lbs/ft}^2 + 1 \text{ lbs/ft}^2 = 5.1 \text{ lbs/ft}^2$ | ✓ |
| 4. Calculate overall weight | $5 \text{ ft}^2 \times 5.1 \text{ lbs/ft}^2 = 26 \text{ lbs}$ | ✓ |

Awning (4” restrictor)

- | | | |
|---|--|---|
| 1. Determine awning size - 42” wide x 36” tall | $(42" \times 36") / 144" = 10.5 \text{ ft}^2$ | ✓ |
| 2. Determine glass weight- Double glazed - 6mm / Air / 5mm. | $3.1 + 2.6 \text{ lbs/ft}^2 = 5.7 \text{ lbs/ft}^2$ | ✓ |
| 3. Calculate weight per square foot (add window framing 1 lbs/ft ²) | $5.7 \text{ lbs/ft}^2 + 1 \text{ lbs/ft}^2 = 6.7 \text{ lbs/ft}^2$ | ✓ |
| 4. Calculate overall weight | $10.5 \text{ ft}^2 \times 6.7 \text{ lbs/ft}^2 = 70 \text{ lbs}$ | ✓ |

Casement

Casement windows require two additional steps. There is a maximum allowable torque load of 50 lbs well as a 2:3, width to height, ratio to consider. Both additional considerations are demonstrated in this example.

- | | | |
|--|---|---|
| 1. Determine casement size – 24" wide x 48" tall | $(24" \times 48") / 144" = 8 \text{ ft}^2$ | ✓ |
| 2. Check that size is within 2:3 width to height ratio
(2:3 ratio = height/3 x 2= max. width) *width must be ≤ the answer | $(48" / 3) \times 2 = 32"; 24" \leq 32"$ | ✓ |
| 3. Determine glass weight - Double glazed unit 4mm / Air / 4mm | = 4.1 lbs/ft ² | ✓ |
| 4. Calculate weight per square foot (add window framing 1 lbs/ft ²) | $4.1 \text{ lbs/ft}^2 + 1 \text{ lbs/ft}^2 = 5.1 \text{ lbs/ft}^2$ | ✓ |
| 5. Calculate overall weight | $8 \text{ ft}^2 \times 5.1 \text{ lbs/ft}^2 = 41 \text{ lbs}$ | ✓ |
| 6. Calculate torque load ⁵ | $8 \text{ ft}^2 \times 5.1 \text{ lb/ft}^2 \times (24/12)/2 = 41 \text{ lbs}$ | ✓ |

Combination Window

When determining the combination window overall area and weight, first ensure individual fixed lites and vent sizes are within Starline's recommended design guidelines (as demonstrated in Step 1-4).

If the fixed lite width exceeds 72", the addition of a vertical coupler is required, thus creating two separate window modules.

If the fixed lite height exceeds 84", the addition of another horizontal T-Bar is required.

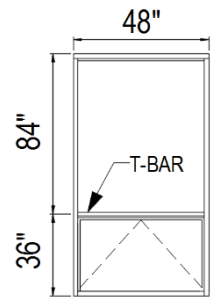

- | | | |
|---|--|---|
| 1. Determine combination window size -48" wide x (84" + 36") tall | $(48" \times 120") / 144" = 40 \text{ ft}^2$ | ✓ |
| 2. Determine glass weight - Double glazed - 4mm / Air / 4mm
4mm glass is ok based on the area of each individual IGU, 28 ft ² for fixed lite and 12 ft ² for vent. | = 4.10 lbs/ft ² | ✓ |
| 3. Calculate weight per square foot (add window framing 1 lbs/ft ²) | $4.10 \text{ lbs/ft}^2 + 1 \text{ lbs/ft}^2 = 5.10 \text{ lbs/ft}^2$ | ✓ |
| 4. Calculate overall weight | $40 \text{ ft}^2 \times 5.10 \text{ lbs/ft}^2 = 204 \text{ lbs}$ | ✓ |

¹ Maximum fixed window area for an insulated glass unit (IGU) is dependent on the glass thickness selected. Once the desired IGU area has been determined, refer to [Maximum IGU Area Based on Glass Lite Thickness](#) to select required glass thickness.

² Glass thickness may be required to be thicker than stated on the Maximum IGU Area Based on Glass Lite Thickness chart due to structural requirements, building code requirements, by-law requirements, etc. As an example: A glass thickness of 5mm may be selected based on the charts and it states 5mm glass can be used up to an IGU area that is 40 sq. ft. maximum for double glazed, however structural requirements due to the buildings wind loading may require 6mm glass thickness to be used. 6mm glass is thicker than 5mm glass and weighs more, so the window size may need to be reduced to keep overall weight within Starline windows recommended maximum weight.

³ If the width exceeds 72", the addition of a vertical coupler is required, thus creating 2 separate window modules. If the height exceeds 84", the addition of a horizontal T-Bar is required³, thus creating a combination window. Refer to Example #5 if the window has become a combination window.

⁴ If the IGU height exceeds 84", the addition of a horizontal T-Bar is required when using Starline's standard coupler. The max. height of 84" for an IGU may be able to be increased using an I-coupler in lieu of a standard coupler. This can be reviewed on a project specific basis.

⁵ Torque Load = Area of Casement (ft²) x Weight of Glass (lb/ ft²) x (Width of Casement (ft) / 2)

Series 9000 Aluminum Window Wall Design Guidelines



Egress Hinge Chart

The following dimensions are based on casement windows.

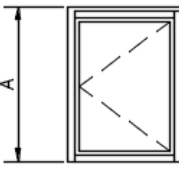
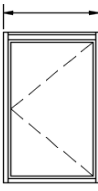
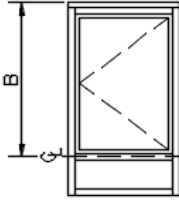
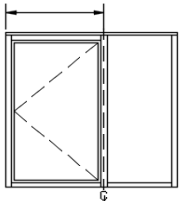
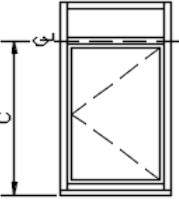
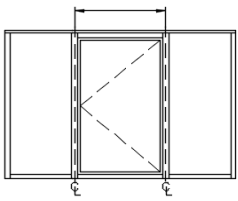
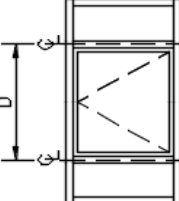
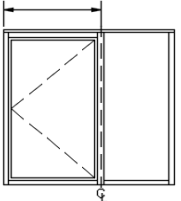
CLEAR OPENING HEIGHT POINT OF MEASUREMENT	WIDTH	HEIGHT	REQUIRED HEEL DIMENSION			
			CANADA		UNITED STATES	
			W	H	W	H
A - HEAD TO SILL 	SEISMIC JAMB TO SEISMIC JAMB 	A	23.50"	43.188"	-	-
		B	23.50"	42.688"	-	-
		C	23.50"	41.938"	-	-
		D	23.50"	41.438"	-	-
B - HEAD TO T-BAR 	SEISMIC JAMB TO COUPLER 	A	23.00"	43.188"	-	-
		B	23.00"	42.688"	-	-
		C	23.00"	41.938"	-	-
		D	23.00"	41.438"	-	-
C - T-BAR TO SILL 	COUPLER TO COUPLER 	A	22.563"	43.188"	-	-
		B	22.563"	42.688"	-	-
		C	22.563"	41.938"	-	-
		D	22.563"	41.438"	-	-
D - T-BAR TO T-BAR 	SEISMIC JAMB TO MULLION 	A	22.50"	43.188"	-	-
		B	22.50"	42.688"	-	-
		C	22.50"	41.938"	-	-
		D	22.50"	41.438"	-	-
MINIMUM CLEAR OPENING			15"	15"	20"	20"
MINIMUM OVERALL SQUARE FOOTAGE			3.8 ft ²	3.8 ft ²	5.7 ft ²	5.7 ft ²

See [Clear Opening Height Point of Measurement](#) for images of where the clear opening height is measured from.

See [Egress Hinge Clear Opening Diagrams](#) for images and calculations for how the clear opening width was calculated.

Note: Starline's Series 9000 casement window using an Egress hinge will not meet the IBC 2021 egress requirements. Starline does not consider awnings for use for egress.

CANADA: NBC 2020 & BCBC 2018 - Part 9 - 9.9.10.1.2

USA: IBC 2021 - Section 1031.3.1, 1031.3.2

It is Starline Windows understanding that this document reflects the current egress requirements in Canada and the USA as of February 1st, 2023, however, codes are subject to change. Contact your local municipal authority to confirm egress requirements in your area. Clearly state egress requirements when ordering windows from Starline as Starline's profiles are subject to change without notice.

Egress 60° Hinge Chart

The following dimensions are based on casement windows.

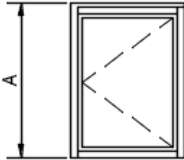
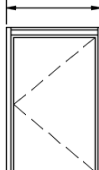
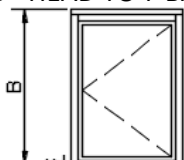
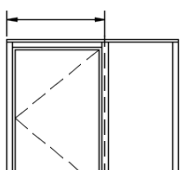
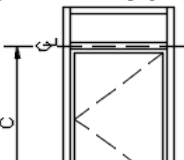
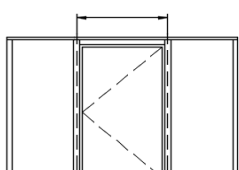
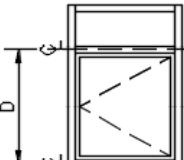
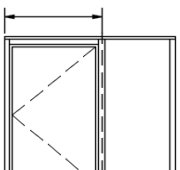
CLEAR OPENING HEIGHT POINT OF MEASUREMENT	WIDTH	HEIGHT	REQUIRED HEEL DIMENSION			
			CANADA		UNITED STATES	
			W	H	W	H
A - HEAD TO SILL 	SEISMIC JAMB TO SEISMIC JAMB 	A	23.813"	47.875"	-	-
		B	23.813"	47.375"	-	-
		C	23.813"	46.625"	-	-
		D	23.813"	46.125"	-	-
B - HEAD TO T-BAR 	SEISMIC JAMB TO COUPLER 	A	23.375"	47.875"	-	-
		B	23.375"	47.375"	-	-
		C	23.375"	46.625"	-	-
		D	23.375"	46.125"	-	-
C - T-BAR TO SILL 	COUPLER TO COUPLER 	A	23.00"	47.875"	-	-
		B	23.00"	47.375"	-	-
		C	23.00"	46.625"	-	-
		D	23.00"	46.125"	-	-
D - T-BAR TO T-BAR 	SEISMIC JAMB TO MULLION 	A	22.875"	47.875"	-	-
		B	22.875"	47.375"	-	-
		C	22.875"	46.625"	-	-
		D	22.875"	46.125"	-	-
MINIMUM CLEAR OPENING			15"	15"	20"	20"
MINIMUM OVERALL SQUARE FOOTAGE			3.8 ft ²	3.8 ft ²	5.7 ft ²	5.7 ft ²

Series 9000 Aluminum Window Wall Design Guidelines

See [Clear Opening Height Point of Measurement](#) for images of where the clear opening height is measured from.

See [60° Egress Hinge Clear Opening Diagrams](#) for images and calculations for how the clear opening width was calculated.

Note: Starline's Series 9000 casement window using a 60° Egress hinge will not meet the IBC 2021 egress requirements.

Starline does not consider awnings for use for egress.

CANADA: NBC 2020 & BCBC 2018 - Part 9 - 9.9.10.1.2

USA: IBC 2021 - Section 1031.3.1, 1031.3.2

It is Starline Windows understanding that this document reflects the current egress requirements in Canada and the USA as of February 1st, 2023, however, codes are subject to change. Contact your local municipal authority to confirm egress requirements in your area. Clearly state egress requirements when ordering windows from Starline as Starline's profiles are subject to change without notice.

Window Hardware

This section covers handles and head trickle vents.

Handles

The standard handles for the Series 9000 operable vents are cam handles made from zinc alloy. 1 or 2 handles will be included, depending on the operable vent size (refer to the chart below). These handles lock positively against a PVC mounted keeper.

Handles and mounted keeper are available in black and white.

The 60 degree hinge is restricted to 4".

Vent Sizes with 1 or 2 Cam Handles

	1 CAM HANDLE	2 CAM HANDLES
AWNING WIDTH	UP TO 30"	30" TO 48"
CASEMENT HEIGHT	UP TO 30"	30" TO 60"

Options

1. Multi-point locking hardware. The multi point handle is available in black and white. The multi points, not visible when window is in closed position, are available in black and white. When multipoint locks are selected, the minimum vent height for a casement is 22" but shall not exceed 60" in height. The minimum vent width is for an awning is 22" but shall not exceed 48" in width.
2. 90° egress hinge.
3. Custodial restrictors.

Note: Top Snubber and Roto Gear Hardware are not available for 9000 series.

Standard Interior Cam Handle

Interior cam handle, made from zinc alloy, positively locks against a mounted keeper. Available in black and white.

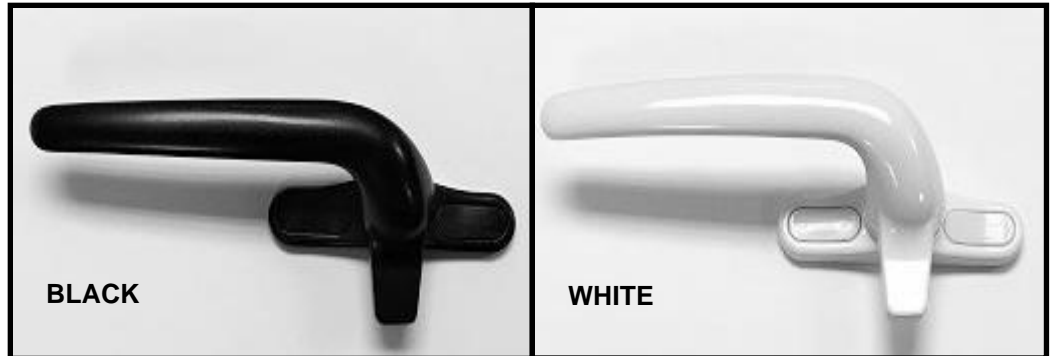

Mounted Keeper for Standard Interior Handle

Interior mounted keeper, made from PVC, enables handle to positively lock against it. Available in black and white.

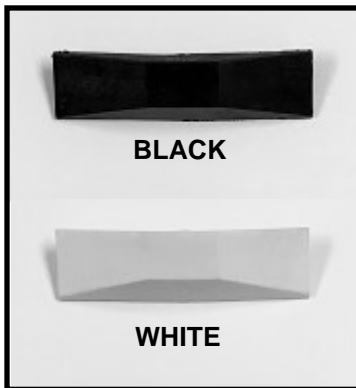

Multi-Point Locking Hardware

The multi point handle is available in black and white. The multi points are not visible when the window is closed. They are available in black and white. When multipoint locks are selected, the minimum vent height for a casement is 22" but shall not exceed 60" in height. The minimum vent width for an awning is 22" but shall not exceed 48" in width.

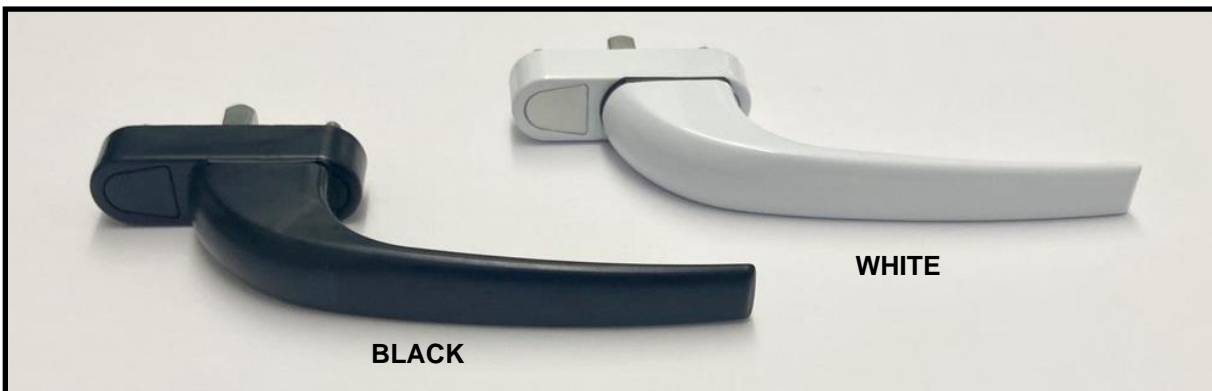

Series 9000 Aluminum Window Wall Design Guidelines

Head Trickle Vents

For each trickle ventilator, the total area of the three air slots is 3.8 square inches. When in an open position, 3.8 square inches of airflow can be expected (air infiltration rating after redundant testing).

The head trickle vent has not been designed to be watertight. Starline Windows cannot guarantee the window wall system will be watertight if trickle vents are used.

The head trickle vent has not been tested for acoustic ratings; expect some localized exterior sound transmission to the interior. Trickle vent assembly is also not tested for thermal performance. Expect localized exterior cooling and heating to be felt in the interior.

The interior vent is available in white and black only; the exterior grill matches the exterior colour of the frame.

More than one trickle vent can be installed per window module, if required, depending on the window module width. The nominal size of the trickle vent is 20". Ex. If two trickle vents were required the window module width would need to be 40".

Window Head Trickle Vent with Exterior Grill & Interior Vent

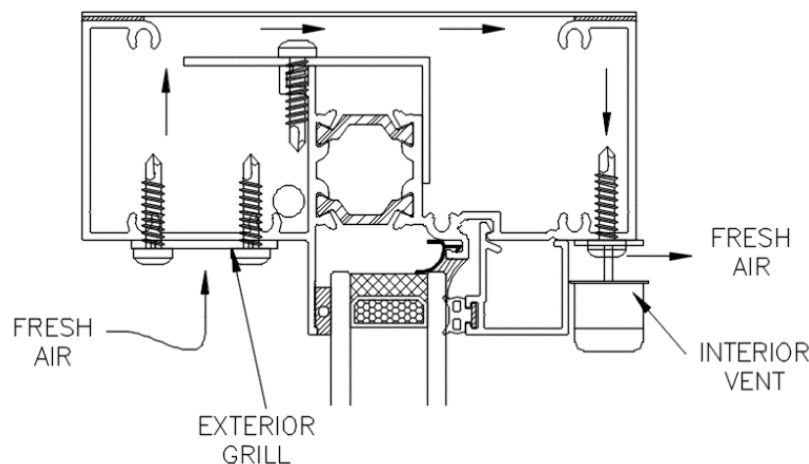

Insulation

The standard Series 9000 insulation is as follows:

- R-Matte plus 3 rigid foam plastic insulation, or equivalent is the standard insulation for aluminum and galvanized steel sandwich panel applications. The overall insulation thickness for sandwich panel is 3/4".
- Rockwool Fabrock 30 and / or Rockwool Fabrock LT mineral wool fibre insulation, or equivalent, with an overall thickness of 3" for spandrel glass, aluminum panel and galvanized panel application. The R-value/inch @ 75°F is 4.1 hr.ft².F/Btu.

The insulation will be installed as follows:

- The deflection header clip, seismic jambs and couplers will be insulated onsite.
- The corner posts (except seismic pocket), jambs and heads will be insulated in the factory.
- The sill cannot be insulated due to wicking concerns.

Bypass Guidelines and Options

Maximum Bypass Height, Weight, and required Nominal Supported Area

The maximum bypass height is 30" when there is a run of windows (two or more).

The maximum bypass height at a single window module (i.e., punched opening) cannot exceed 12". If a larger bypass at a single window module is required, then the seismic jamps can be reversed, given the bypass height does not exceed 30" and the overall window module weight does not exceed 100 pounds.

The standard bypass detail comes with a bypass flashing, not with rod and caulk. The rod and caulk detail is not preferred by Starline due to insufficient overlapping of the membrane at the deflection header.

The recommended nominal supported area is 2 1/8".

The maximum supported area at the bypass is 2 5/16".

The minimum supported area at the bypass is 1 3/4", however the minimum support of 1 3/4" may not exceed 30% of the opening without Starline's structural engineer approval.

There may be the option to decrease the minimum supported area up to 1 5/8", however, Starline's structural engineer must be consulted and approve this project specific request.

There are various options for bypass panels with respects to material selection, thickness of insulation at the slab edge, and various conditions the bypass can accommodate such as in-slab ducts, louvers, stage anchors, electrical penetrations, etc.

The following information is to provide a few examples the various options available. More options may be available and can be reviewed on a project specific basis.

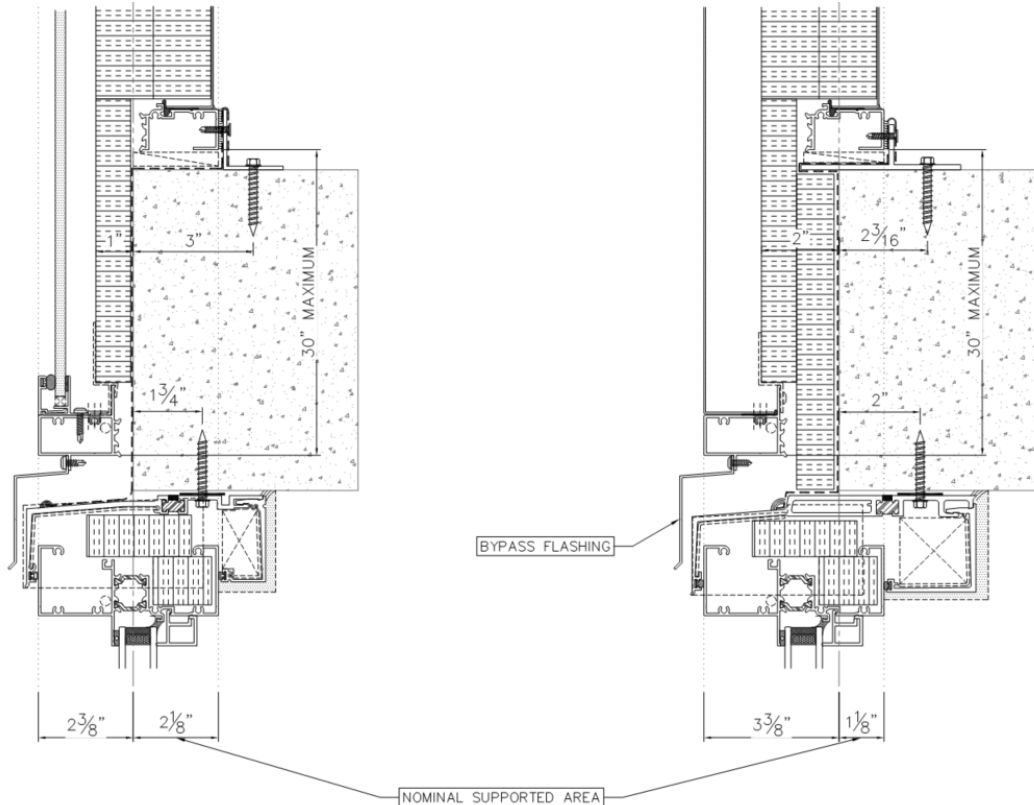

Series 9000 Aluminum Window Wall Design Guidelines

Exterior and Interior Material for Bypass and other Opaque Areas

The following standard exterior and interior material combinations are available for the bypass and other opaque areas:

- Spandrel glass lite on exterior with either an aluminum or galvanized panel on interior.
- Flush metal panel on exterior with either an aluminum or galvanized panel on interior.
- Top Hat metal panel on exterior with either an aluminum or galvanized panel on interior.
- Corrugated metal panel is available in three different options:
 - Rectangular 1" x 2" extrusion on the exterior with either an aluminum or galvanized panel on the interior.
 - Rectangular 1" x 4" extrusion on the exterior with either an aluminum or galvanized panel on the interior.
 - Curved sheet panel extrusion on the exterior with either an aluminum or galvanized panel on the interior. The flutes are 7/8" deep and are spaced 2 11/16" center to center.
- 1", 2", and 4" raised metal panel on exterior with either an aluminum or galvanized panel on interior.
- Spandrel IGU on exterior with either an aluminum or galvanized panel on interior.¹

Refer to the **Metal Panel & Spandrel Glass Design Guidelines** document in the Miscellaneous section of the catalogue for further information.

¹ When a spandrel IGU is selected an alternative bypass detail (DC7) is used in lieu of Starline's standard bypass detail (DC6). Refer to the spandrel glass insulated glass unit image on page 24 as well as the section titled [Insulation at Slab Edge](#) for description on the DC6 versus DC7 detail.

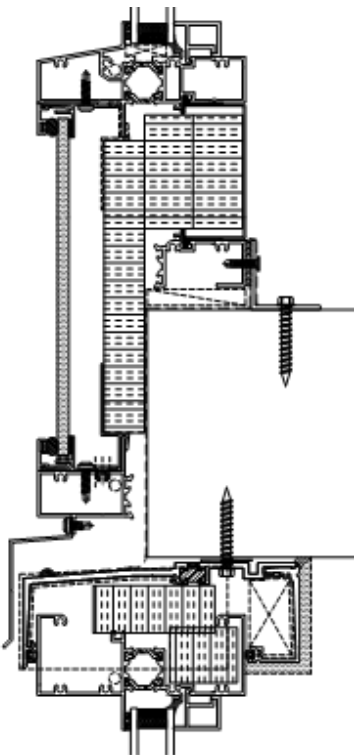

EXTERIOR: SPANDREL GLASS
INTERIOR: ALUMINUM BACK PAN

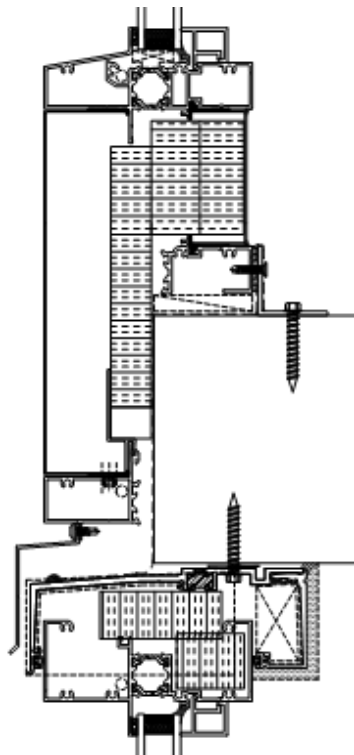

EXTERIOR: FLUSH METAL PANEL
INTERIOR: GALVANIZED BACK PAN

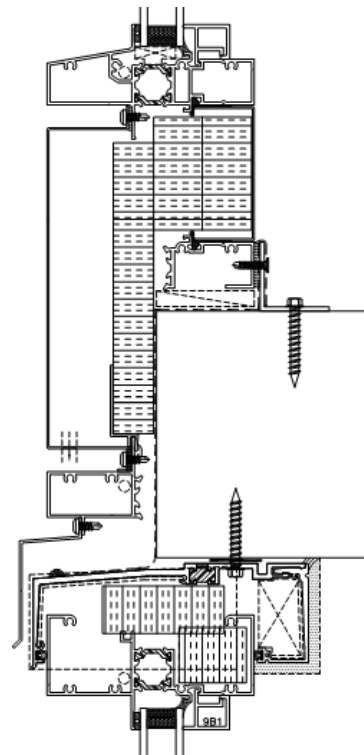

EXTERIOR: TOP HAT PANEL
INTERIOR: ALUMINUM BACK PAN

Also available with galvanized back pan

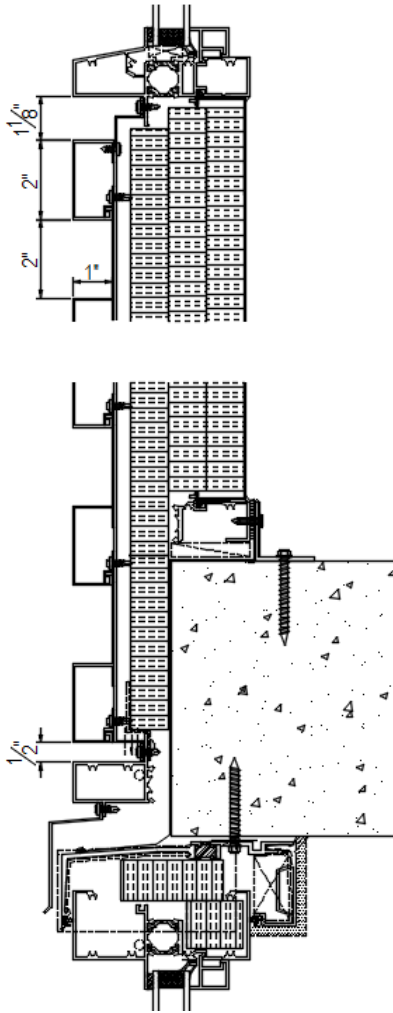

EXTERIOR: 1" x 2" CORRUGATED PANEL
 INTERIOR: GALVANIZED BACK PAN
 Also available with aluminum back pan

Also available with aluminum back pan

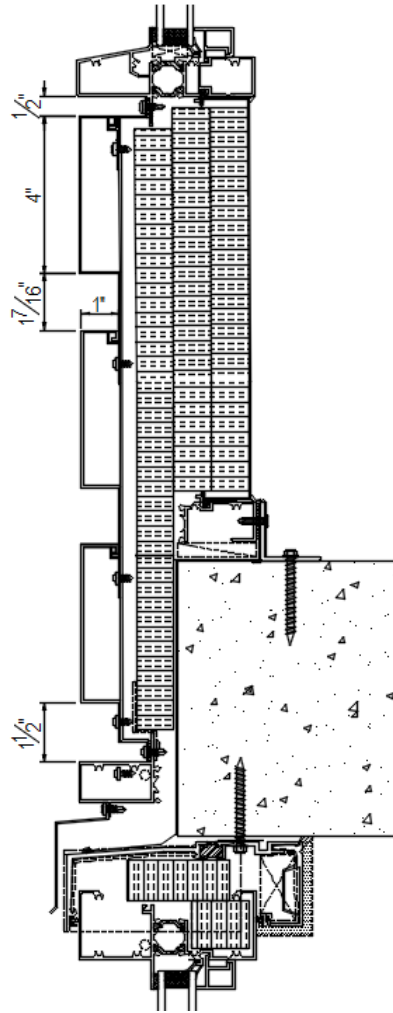

EXTERIOR: 1" x 4" CORRUGATED PANEL
 INTERIOR: GALVANIZED BACK PAN
 Also available with aluminum back pan

Also available with galvanized back pan

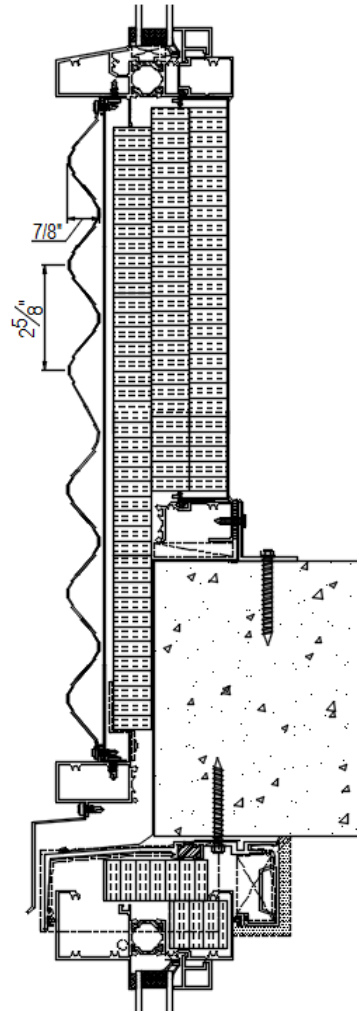

EXTERIOR: CURVED CORRUGATED PANEL
 INTERIOR: GALVANIZED BACK PAN
 Also available with aluminum back pan

Series 9000 Aluminum Window Wall Design Guidelines

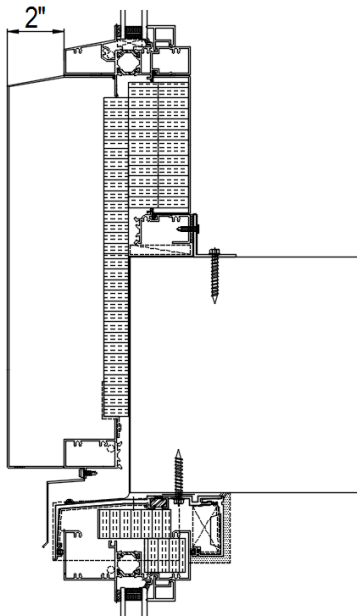

EXTERIOR: 2" RAISED METAL PANEL
 Also available in 1" and 4" raised metal panel
 INTERIOR: ALUMINUM BACK PAN
 Also available with galvanized back pan

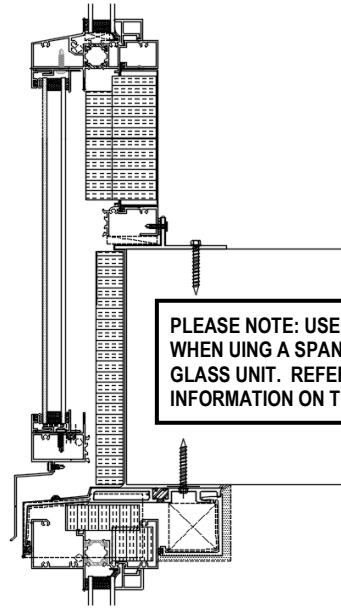

PLEASE NOTE: USE OF DC7 DETAIL REQUIRED WHEN USING A SPANDREL GLASS INSULATED GLASS UNIT. REFER TO SECTION BELOW FOR INFORMATION ON THE DC7 DETAIL

EXTERIOR: SPANDREL INSULATED GLASS UNIT
 INTERIOR: ALUMINUM BACK PAN
 Also available with galvanized back pan

Insulation at the Slab Edge

A thermal resistance of ~R3 is anticipated at the slab edge when using Starline's standard bypass detail (DC6). There is an option to add 1" of continuous insulation using an alternative bypass detail (DC7), which would result in ~R6 at the slab edge. Using the DC7 detail involves some specific detailing including, upgrading to a 7" head deflector (standard is 6"), using a T-angle for the installation sill angle (standard is an L-angle), and add 1" of continuous insulation. The DC7 detail is available at an additional cost.

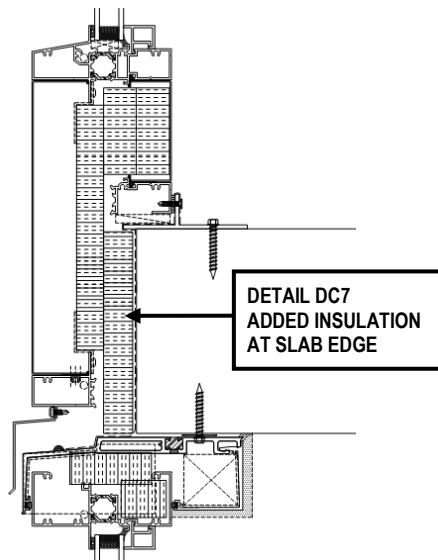
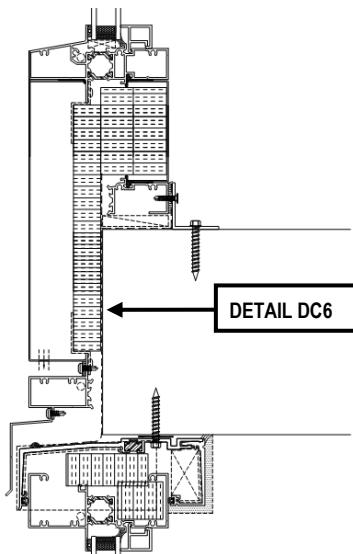

Please note: Project specific detailing such as cutting the slab edge back 1" to accommodate additional insulation is required and is by others.

In-Slab Ducts

There are bypass options to accommodate in-slab ducts. Spandrel glass or aluminum panels are available for the exterior material.

When using a top hat metal panel or spandrel glass, there is a 2" opening left near the bottom of the bypass to provide an opening for the duct to vent out.

If using a 2" or 4" raised metal panel, there is a 2" opening at the bottom of the 2" raised panel at the bypass to provide an opening for the duct to vent out. A 1" raised metal panel cannot vent out the bottom as it does not allow enough air flow.

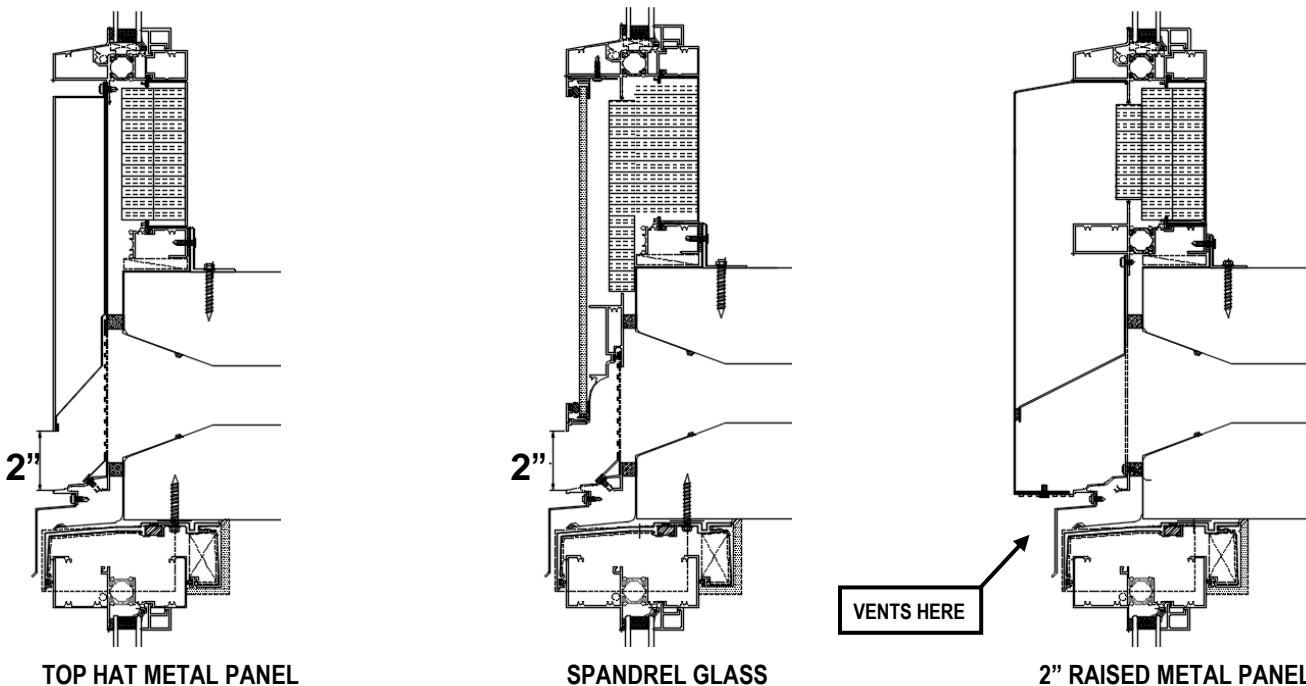

Transom Ducts

If the project is not ducting out the slab, Starline has transom ducts available. The same options as noted above in the **In-Slab Duct** section are available for the transom duct.

The image on the right shows a transom duct. This example is using a top hat panel.

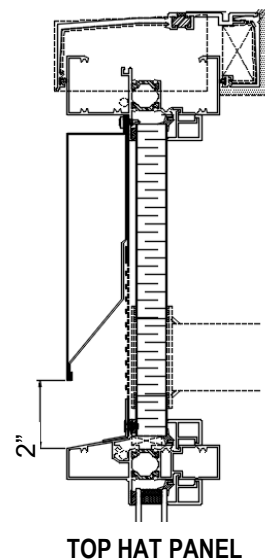

Series 9000 Aluminum Window Wall Design Guidelines



Electrical, Mechanical, and Other Penetrations

Electrical, mechanical and other cut-outs can be made in top hat, aluminum, or sandwich panels. Cut-outs cannot be made into spandrel glass. Starline recommends that a top hat panel is used for all penetrations where possible.

If the cut outs are shown on Starline's approved shop drawings, Starline will manufacturer the cut outs in the factory. If the cut outs are not shown on the shop drawings the specific trade will be required to make the cut-out in the field (on site). The trade which requires the cut out will be responsible for making the cut-out air and watertight (collars, fittings, sealant, etc.) and are to provide a localized warranty at the cut-out.

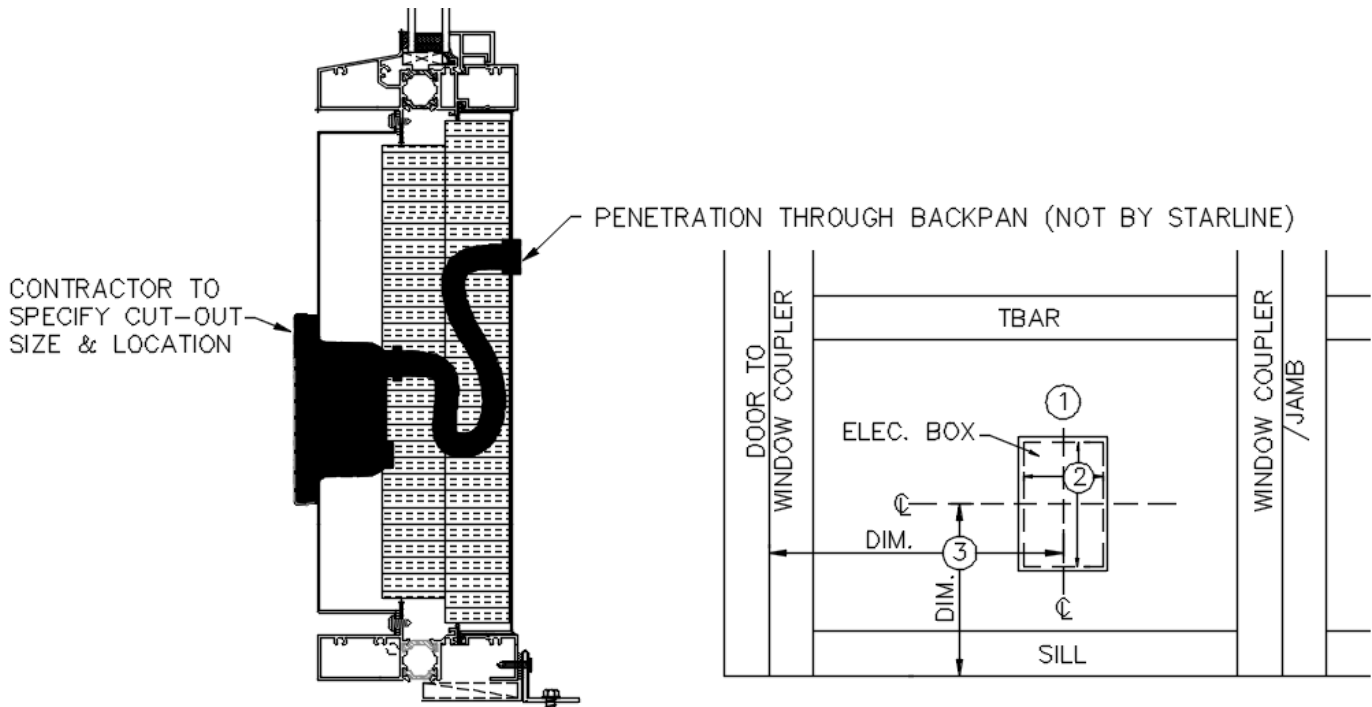

NOTE TO CONTRACTOR:
PLEASE CONFIRM THE FOLLOWING:

- 1 - ORIENTATION OF ELECTRICAL BOX HORIZONTAL OR VERTICAL
- 2 - SIZE OF CUT OUT REQUIRED IN METAL PANEL (WIDTH x HEIGHT)
- 3 - CENTER LOCATION OF CUT OUT FROM BOTTOM OF FRAME & VERTICAL COUPLER OR SPECIFY TO BE CENTERED ON PANEL. (HORIZONTAL & VERTICAL)

Setbacks Required for Columns and Shear walls

A minimum of 3" is required from the face of a column/shear wall to the interior face of the mullion when the standard DC6 detail is used.

A minimum of 4" is required from the face of a column/shear wall to the interior face of the mullion when the DC7 detail is used. The DC7 detail has a 1" deeper deflection header and uses a T-angle for installation, allowing for 1" of continuous insulation at the slab edge.

5" minimum is required from face of a column/shear wall to the edge of the slab for both the DC6 and DC7.

The minimums noted above may need to increase depending on the size of the column/shear wall. These minimums are in place so the installers can fit a caulking gun between the deflection header and column/shear wall and caulk the deflection header. The caulking provides the air barrier for the window system and is critical for a sound building envelope tie-in.

For example, a column which is 2'0" wide running along the face of window wall would be ok using the minimum distances stated above. As the column or shear wall length increase so will the minimums. For example, a 4'-0" long shear wall requires at least 6" from face of a column/shear wall to the edge of the slab.

Refer to [Insulation at the slab edge](#), for images and further description of the DC6 versus DC7 deflection header.

6" Deep Deflection Header

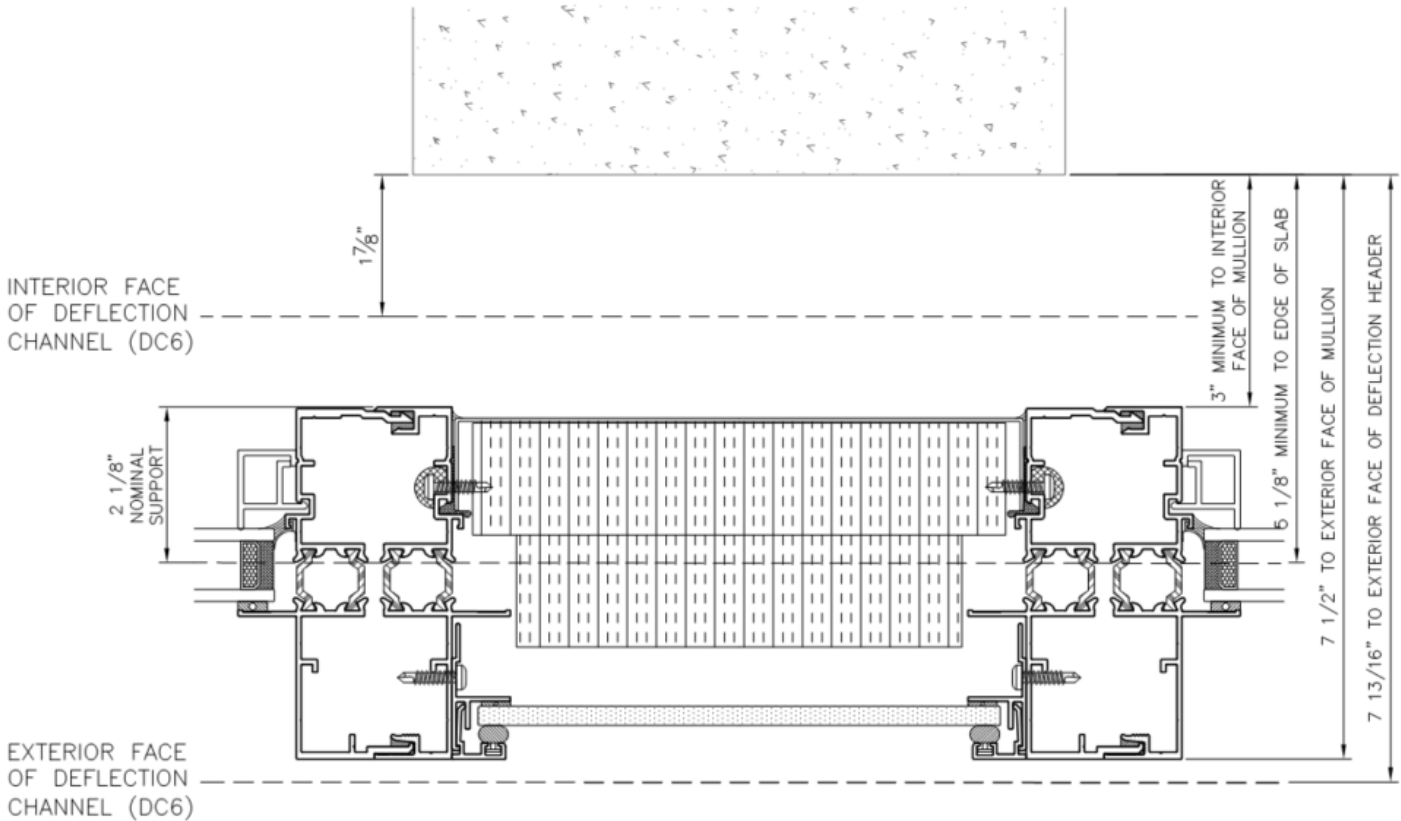

Series 9000 Aluminum Window Wall Design Guidelines



7" Deep Deflection Header

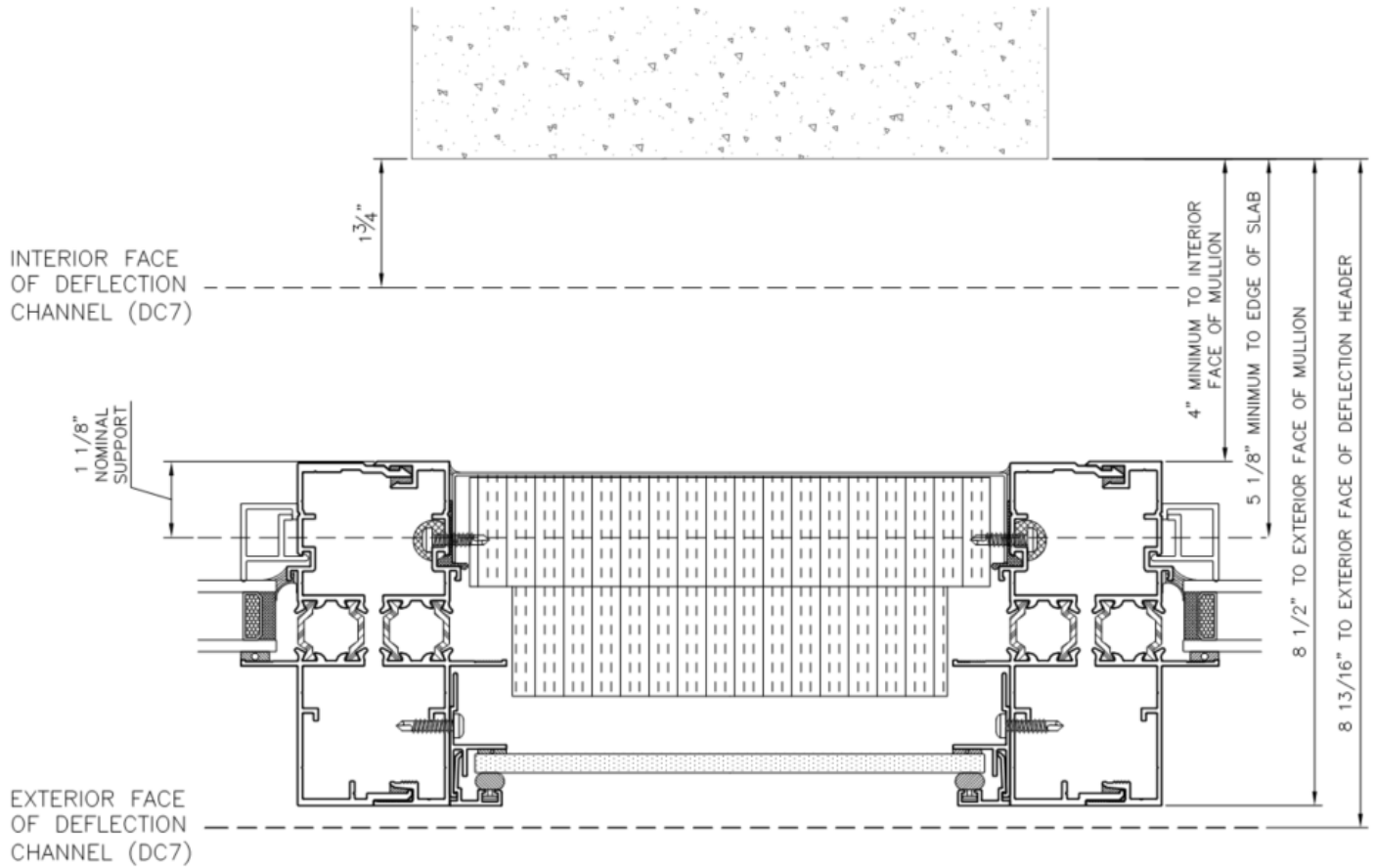

Stage Anchors

Stage anchors, by others, can be incorporated into Starline’s window wall system. These stage anchor inserts are inserted into the window wall vertical coupler, ~6” up from the sill, and is engineered to withstand 600 pounds in any direction. These anchors can provide a permanent anchorage solution for window washing, building and façade maintenance, etc.

Starline preps the window wall to receive a stage anchor, however, the stage anchors and required accessories are by others. Not all stage anchors work with the window wall series – Details can be reviewed on a project specific basis.

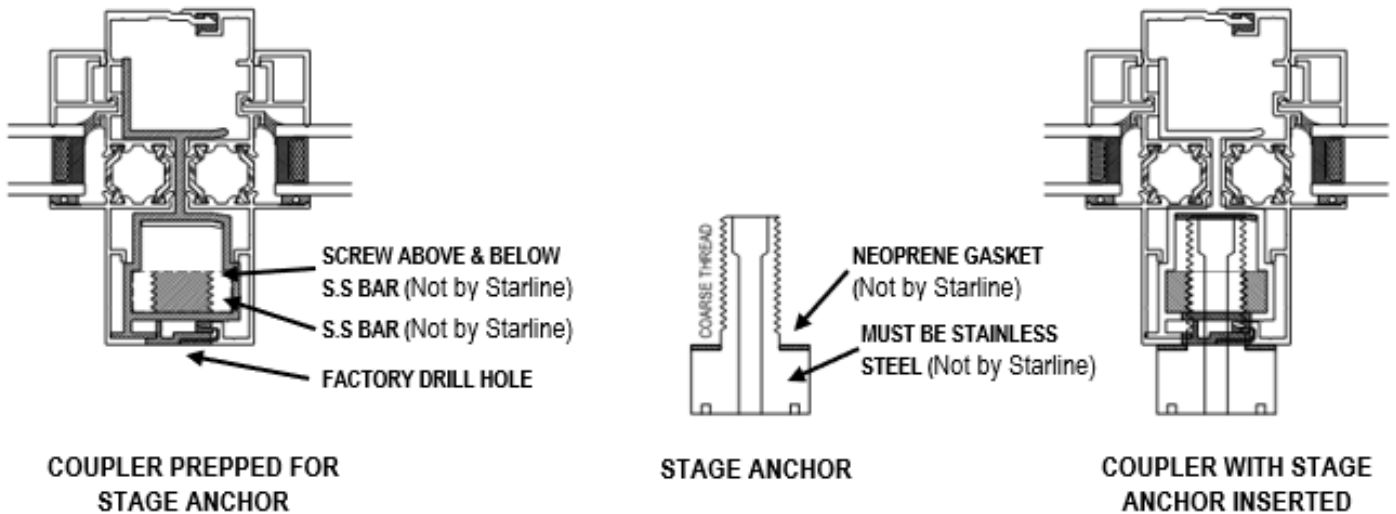

Note: Raised metal panels cover the couplers, therefore, they are not able to be used in locations where stage anchors are required, per the standard raised metal panel design. If a stage anchor is required where a raised metal panel is located, the panel would project straight out from the coupler and not cover the couplers, as shown in the image below.

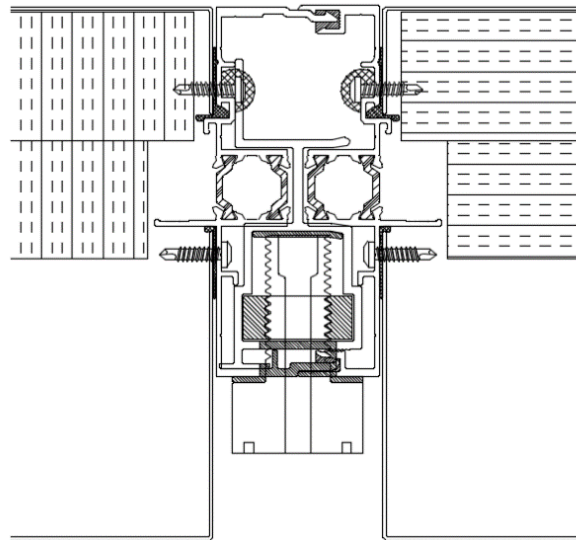

Series 9000 Aluminum Window Wall Design Guidelines



Grilles

Grilles stay in a stationary position and are manufactured by Starline Windows.

Starline does not provide the flappers (which move), these are typically done by the mechanical trade. Starline Windows does not control, nor take responsibility for how well the flappers seal.

The grille can be placed above or below the slab and can be used in conjunction with any of the various bypass panel options at the slab

Starline does not offer a rated grille with respects to air infiltration and exfiltration or water penetration resistance.

Maximum width of 36" and maximum area of 10 sq. ft. overall are the recommended size guidelines for grilles.

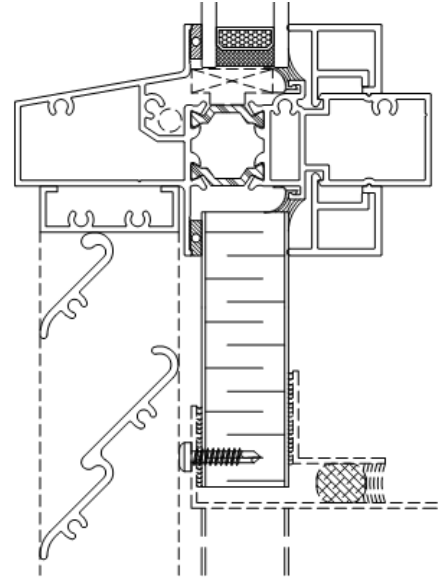

Climb Deterrents

A project may have a requirement for a climb deterrent.

A climb deterrent will prevent the facilitation of climbing.

Starline Windows offers a climb deterrent that is fastened on the exterior sill of a fixed window and fastened to the exterior sill of the sash on an operable venting window.

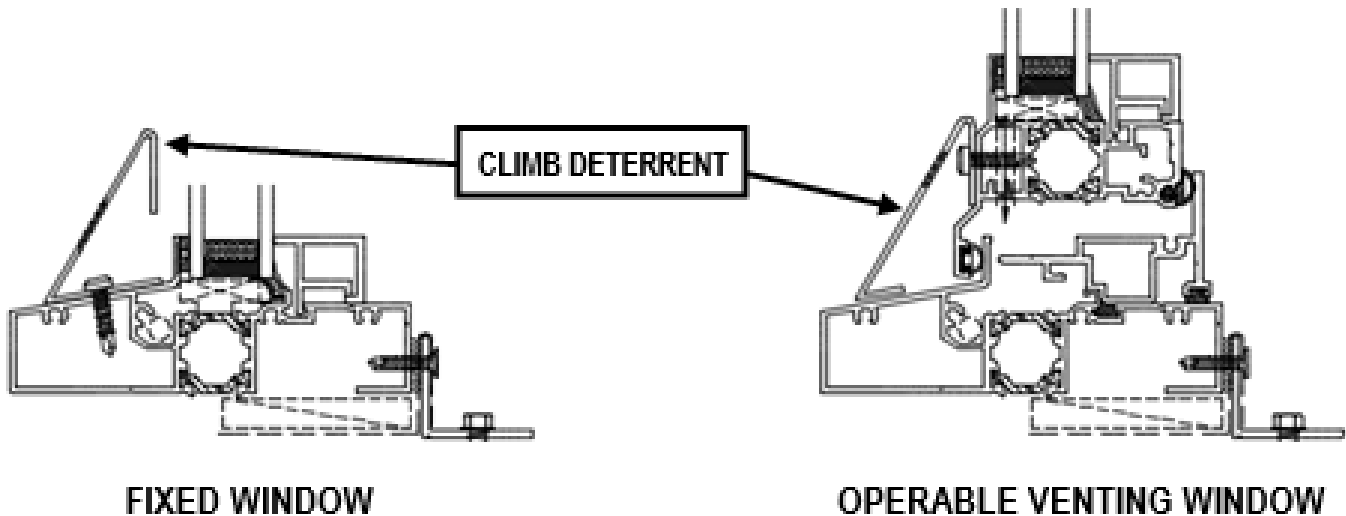

Finishes (Powder Coating)

Starline uses a thermoset coating specifically designed for architectural systems. This coating complies with the American Architectural Manufacturers Association (AAMA) 2603 specification standard which covers pigmented organic coatings on aluminum extrusions.

There are options to upgrade the powder to meet the AAMA 2604 or AAMA 2605 specification on the exterior which is noted in the **Options** section below.

Options

There is an option to upgrade the powder coating to meet the following AAMA standards:

- A thermoset super durable coating which complies with the AAMA 2604 specification standards. The AAMA 2604 standard demands advanced levels of weather resistance, gloss and colour retention, and corrosion resistance, among other increased standards when compared to the AAMA 2603 specification standard.
- A thermoset fluorocarbon coating which is a superior coating that complies with the AAMA 2605 specification standard. The AAMA 2605 standard demands advanced levels of weather resistance, gloss and colour retention, and corrosion resistance, among other increased standards when compared to the AAMA 2603 and AAMA 2604 specification standards.

Note: AAMA 2604 or AAMA 2605 specification standard on exterior of frames may be required in some building codes, bylaws, jurisdictions, etc.

Custom colours may be available on a project-specific basis.

Dual frame colour is available.

Items listed in this **Options** section are available at an additional cost.

Colour Options

The following **standard colours** are available in AAMA 2603, AAMA 2604 and AAMA 2605 specification standards:

White

Black

Brown

Silver

Charcoal Grey

Custom colours are also available. Virtually any colour can be matched or very closely matched. The scope of work and overall custom colour quantity will be reviewed by Starline on a project specific basis to determine the feasibility of the custom colour request.

Note: Custom colours are available for an additional cost premium. An approximate 12-week lead time is required to procure custom colour requests.

Refer to the **Aluminum Finishes (Powder Coating)** document in the Miscellaneous section of the catalogue for images of the standard colours available, a comparison of some attributes which are tested for in the AAMA 2603, AAMA 2604 and AAMA 2605 specification standards, information on colour retention, and details to consider when selecting colours.

Series 9000 Aluminum Window Wall Design Guidelines



Glazing

Starline Windows standard insulated glass unit (IGU) will be comprised of the following glass make-up:

- Double glazed, double sealed IGU with an overall nominal thickness of 7/8" (23 mm).
- Standard high performance soft coat (sputtered) Low E which is applied to surface #2.
- Black warm edge spacer with argon fill.
- Minimum glass thickness is 4mm.

Triple glazed is available - Series 9203 Window Wall.

Additional options are available for an additional cost.

Maximum Area of IGU

GLASS TYPE	SINGLE LITE	DOUBLE GLAZED			TRIPLE GLAZED		
	6mm	4mm	5mm	6mm & THICKER	4mm	5mm	6mm & THICKER
Annealed	–	30 sq.ft.	40 sq.ft.	40 sq.ft.	30 sq.ft.	35 sq.ft.	35 sq.ft.
Tempered	–	30 sq.ft.	40 sq.ft.	40 sq.ft.	30 sq.ft.	35 sq.ft.	35 sq.ft.
Laminated	–	–	–	28 sq.ft. ¹	–	–	28 sq.ft. ¹
Spandrel	40 sq.ft.	–	–	–	–	–	–
Spandrel IGU ²	–	30 sq.ft.	40 sq.ft.	40 sq.ft.	–	–	–

When determining the size of the IGU, it is important to keep in mind the maximum span for the horizontal T-Bar and vertical coupler, as these spans can drive the overall dimensions and size of the IGU.

Maximum span for a horizontal T-bar without a vertical coupler is 72".

Maximum span for a vertical coupler without the use of a horizontal T-bar is 84". This span may be able to increase to 96", as reviewed on a project specific basis to determine the maximum allowable span.

¹ Note:

- 6mm laminated glass can be to a max area of 28 sq.ft.
- 6mm tempered laminated glass can be to a max area of 19.5 sq.ft.; max united inches <105".
- 8mm laminated can be to a max area of 35 sq.ft.
- 8mm tempered laminated glass can be to a max area of 30 sq.ft.; max united inches <150".
- 10mm laminated can be to a max area of 40 sq.ft.
- 10mm tempered laminated glass can be to a max area of 41 sq.ft.; max united inches <175".

United inches = One width + one height.

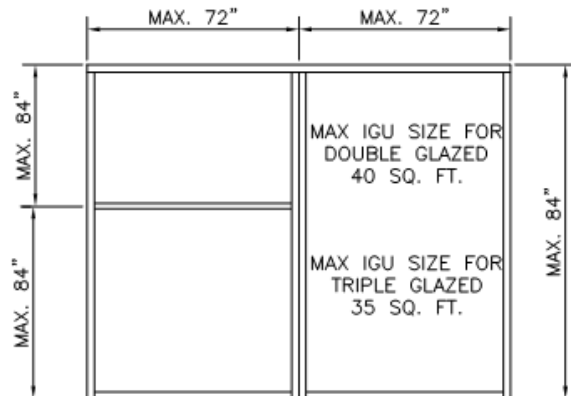

² The Spandrel glass lite is always minimum 6mm thick. For a spandrel IGU the spandrel lite must be the inboard lite and ceramic frit is required to be used.

Aspect Ratio of Glass

The maximum width to height ratio is 5:1 for any glass selected, less single lite spandrel glass which is 8:1.

Refer to the **Aluminum Glass & IGU Design Guidelines** document for more detailed information regarding size limitations, available configurations, defects, and definitions.

IGU Chart

Based on a 23mm IGU

Overall thickness of primary seal (Butyl): 0.8mm

EXTERIOR		SPACER		INTERIOR	
mm	inch	mm	inch	mm	inch
4	5/32	14.6	9/16	4	5/32
5	3/16	12.6	1/2	4	5/32
5	3/16	12.6	1/2	5	3/16
6	1/4	12.6	1/2	4	5/32
6	1/4	11.6	7/16	5	3/16
6	1/4	11.6	7/16	6	1/4
6LAM .030	1/4 .030	11.6	7/16	4	5/32
6LAM .030	1/4 .030	9.6	3/8	6	1/4

Note:

- The IGU, glass thickness and spacer bar size are based on nominal dimension. Actual dimensions will vary slightly.
- There are other glass make-up combinations available other than noted in the above chart. The chart's purpose is to provide a few examples. Other available combinations can be reviewed on a project-specific basis.

Series 9000 Aluminum Window Wall Design Guidelines



Acoustical Ratings Based on 23mm Double Glazed IGU

GLASS EXT.	GAP	GLASS INT.	TEST NUMBER	STC	OITC
4mm Ann.	14mm AIR	4mm Ann.	TL7227	33	27
5mm Ann.	14mm AIR	5mm Ann.	TL7226	34	28
4mm Ann.	16mm AIR	5mm Ann.	TL7225	37	30
6mm Lam. (PVB 0.8mm)	10mm AIR	6mm Lam. (PVB 0.8mm)	TL2584	38	30
4mm Ann.	13mm AIR	6mm Ann.	TL7334	36	31
5mm Ann.	13mm AIR	6mm Ann.	TL7341	37	31
4mm Ann.	13mm AIR	6mm Lam. (PVB 0.8mm)	TL7296	38	31
6mm Ann.	9mm AIR	8mm Ann.	ARL-TL9126	37	32

Performance Test Results

Canada

PRODUCT DESIGNATOR	AIR TIGHTNESS	WATER PENETRATION RESISTANCE		UNIFORM LOAD STRUCTURAL	RESISTANCE TO FORCED ENTRY
		LAB TESTED	FIELD TEST ^{1,2}		
AW-PG60	A3	720 Pa	500Pa	2880 Pa	Grade 20

Series 9000 muller assembly window has been tested to AAMA/WDMA/CSA 101 I.S.2/A440-08 and CSA A440SI-09

USA

PRODUCT DESIGNATOR	AIR TIGHTNESS	WATER PENETRATION RESISTANCE		UNIFORM LOAD STRUCTURAL	RESISTANCE TO FORCED ENTRY
		LAB TESTED	FIELD TEST ^{1,2}		
AW-PG60	0.01 CFM/ft ² @ 6.24 psf	15.04 psf	10.4 psf	90 psf	Grade 20

Series 9000 muller assembly window has been tested to AAMA/WDMA/CSA 101 I.S.2/A440-08 and CSA A440SI-09

Note: Window complies with ASTM F588 (Forced Entry Resistance).

Operating force when tested to ASTM E2068 exceeds the requirement for AW rating.

¹ Water penetration resistance field tests follow the criteria and testing procedures as outlined in the AAMA 502-21 specification standard.

² 500Pa / 10.4 psf is the maximum field test result that can be achieved. If the Project Specifications state a water penetration resistance field test pressure of a lesser value, the project specified values shall govern.

Clear Opening Height Point of Measurement

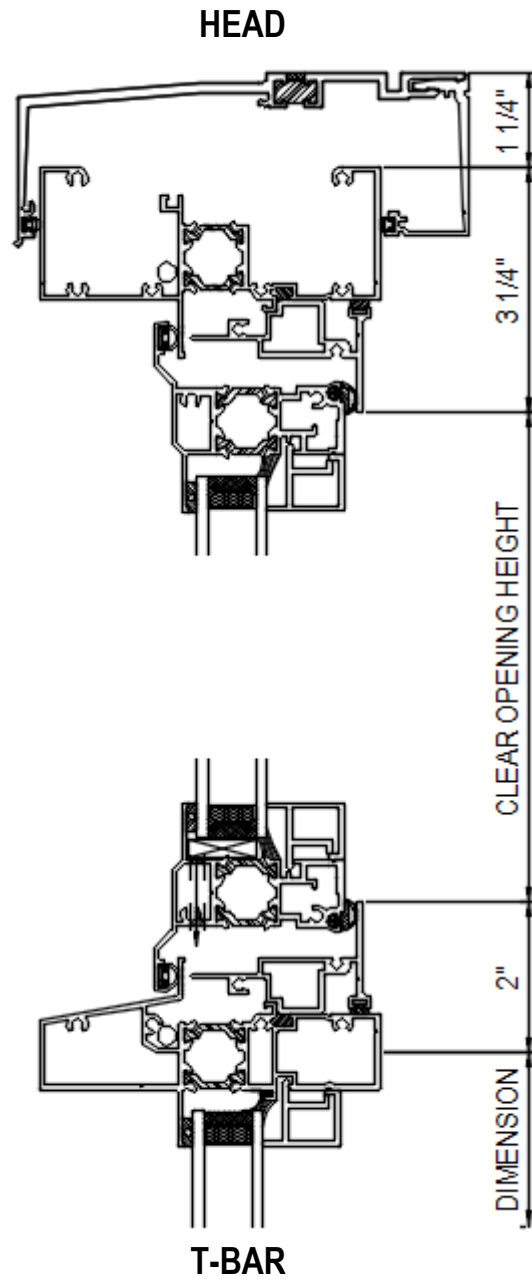
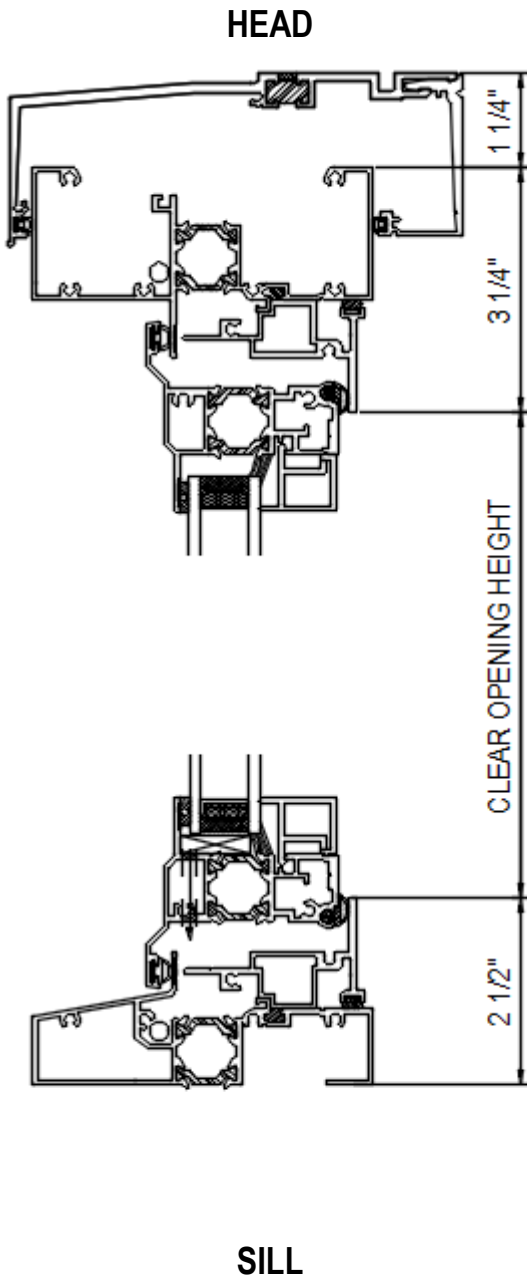

Series 9000 Aluminum Window Wall Design Guidelines

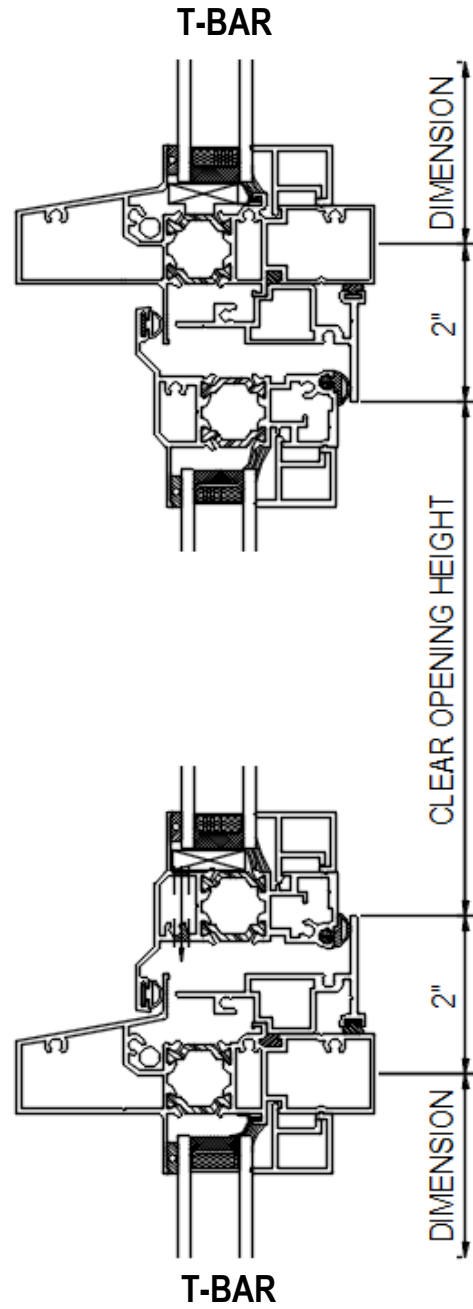
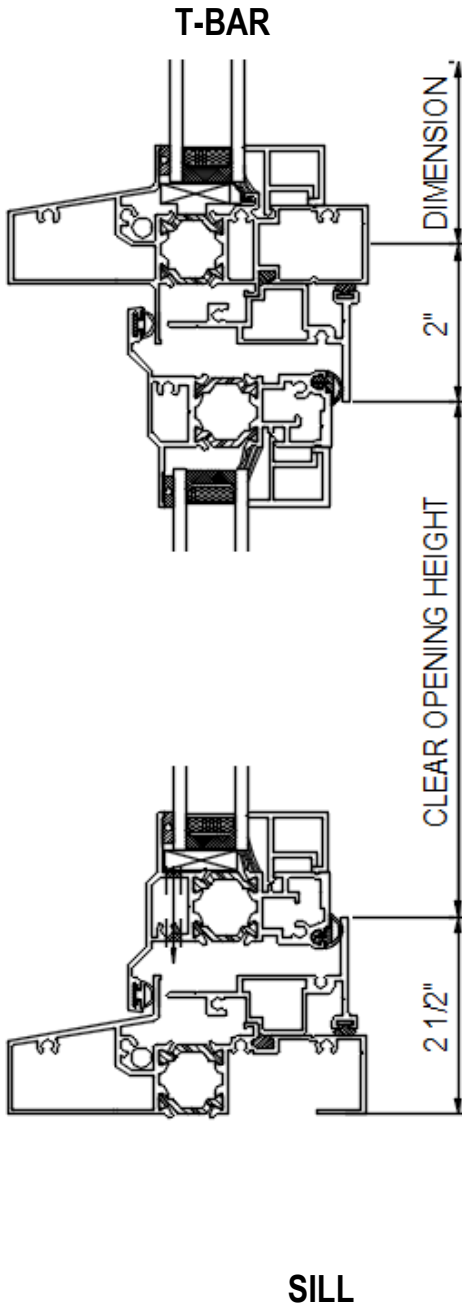

Egress Hinge Clear Opening Diagrams

Clear Openings Between Seismic Jamb

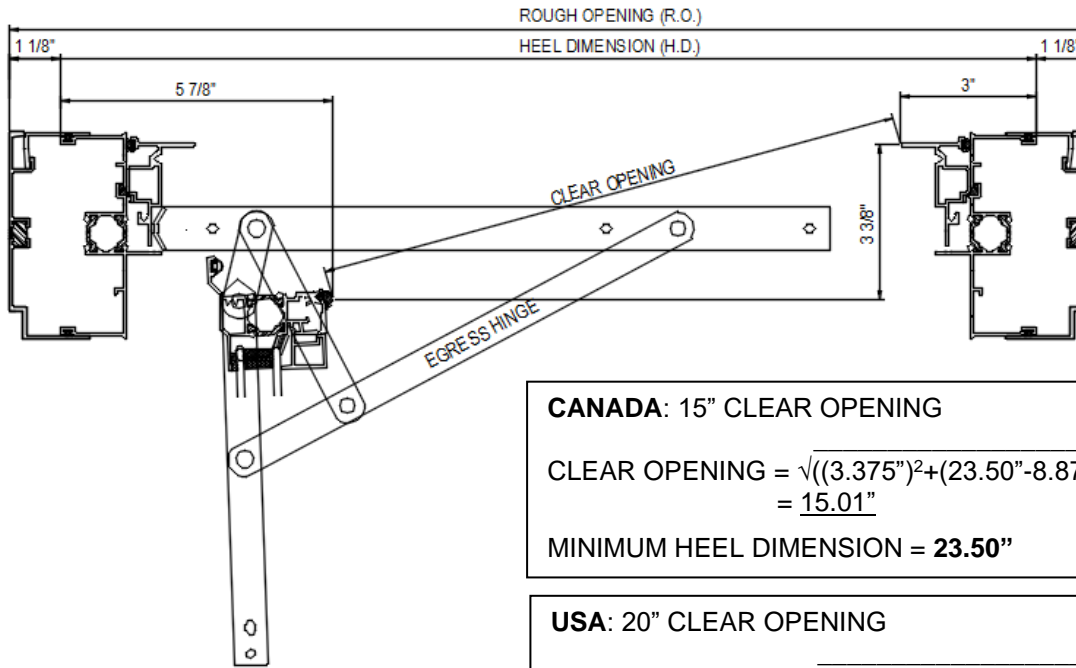

CANADA: 15" CLEAR OPENING

$$\text{CLEAR OPENING} = \sqrt{((3.375")^2 + (23.50" - 8.875")^2)}$$

$$= \underline{15.01"}$$

MINIMUM HEEL DIMENSION = **23.50"**

USA: 20" CLEAR OPENING

$$\text{CLEAR OPENING} = \sqrt{((3.375")^2 + (28.625" - 8.875")^2)}$$

$$= \underline{20.04"}$$

MINIMUM HEEL DIMENSION = **28.625"**

$$\text{CLEAR OPENING} = \sqrt{((3.375)^2 + (\text{FRAME DIMENSION} - 8.875)^2)}$$

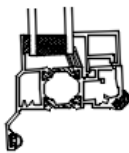

STARLINE WINDOWS IS NOT RESPONSIBLE FOR DETERMINING THE CLEAR OPENING IN ANY JURISDICTION.

Limitation of Casements:

MIN HEIGHT = 15"

MIN WIDTH = 19"

MAX. HEIGHT = 60"

MAX. WIDTH = 30"

MAX. AREA = 10.0 SF

MAX. WEIGHT = 50 lbs

MAX. TORQUE LOAD = 50 POUND*FOOT

Series 9000 Aluminum Window Wall Design Guidelines



Clear Openings Between Seismic Jamb and Coupler

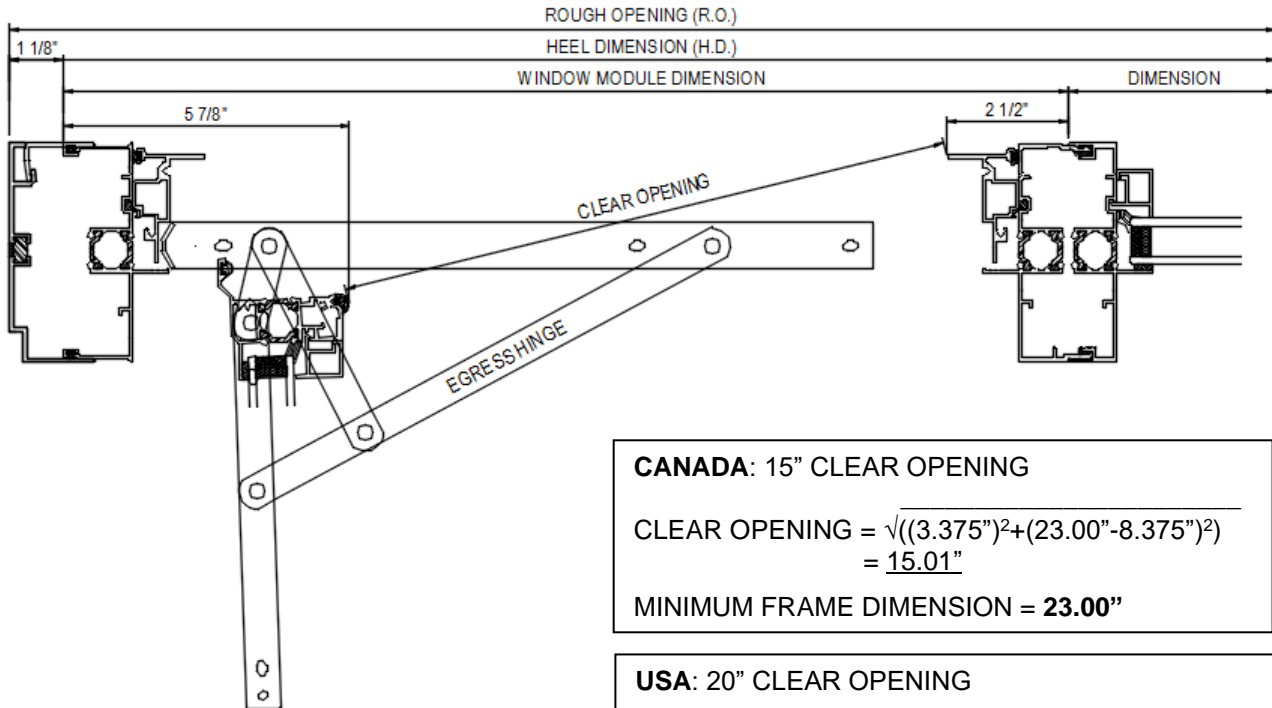

CANADA: 15" CLEAR OPENING

$$\text{CLEAR OPENING} = \sqrt{((3.375")^2 + (23.00" - 8.375")^2)}$$

$$= \underline{15.01"}$$

MINIMUM FRAME DIMENSION = 23.00"

USA: 20" CLEAR OPENING

$$\text{CLEAR OPENING} = \sqrt{((3.375")^2 + (28.125" - 8.375")^2)}$$

$$= \underline{20.04"}$$

MINIMUM FRAME DIMENSION = 28.125"

$$\text{CLEAR OPENING} = \sqrt{((3.375)^2 + (\text{FRAME DIMENSION} - 8.375)^2)}$$

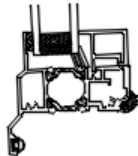

STARLINE WINDOWS IS NOT RESPONSIBLE FOR DETERMINING THE CLEAR OPENING IN ANY JURISDICTION.

Limitation of casements:

- | | |
|----------------------------------|----------------------|
| MIN HEIGHT = 15" | MIN WIDTH = 19" |
| MAX. HEIGHT = 60" | MAX. WIDTH = 30" |
| MAX. AREA = 10.0 SF | MAX. WEIGHT = 50 lbs |
| MAX. TORQUE LOAD = 50 POUND*FOOT | |

Clear Openings Between Couplers

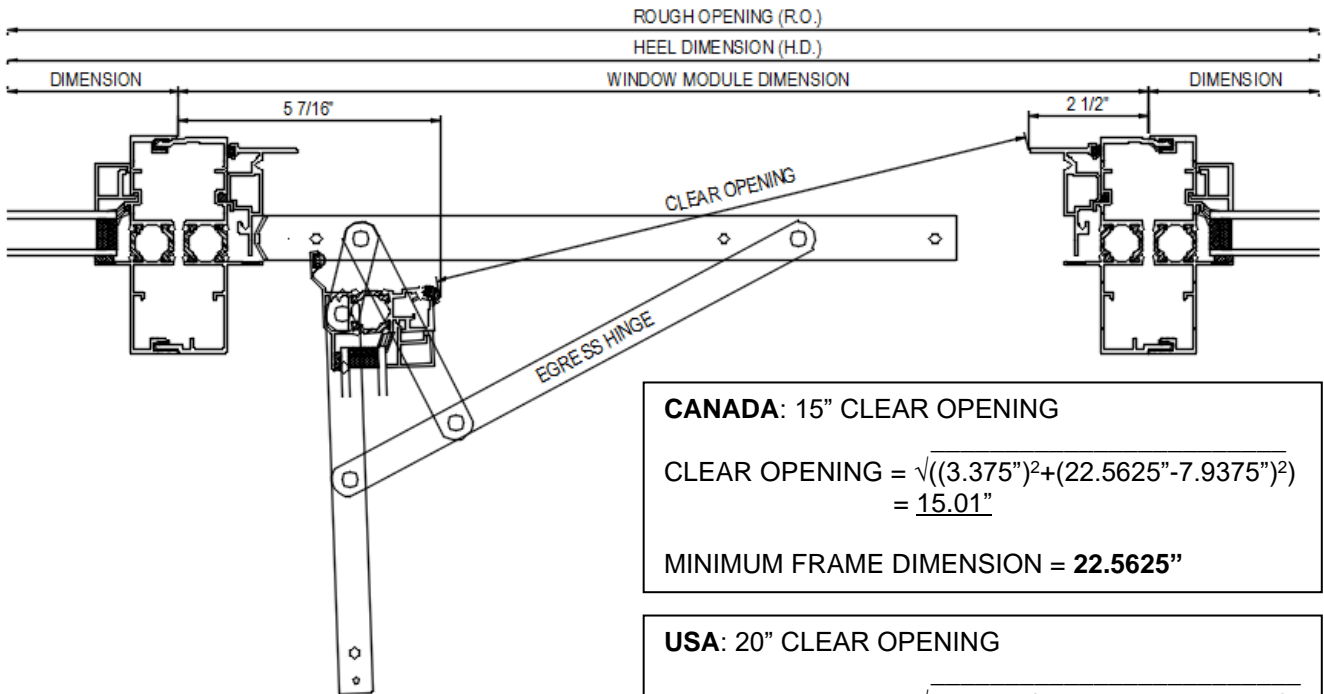

CANADA: 15" CLEAR OPENING

$$\text{CLEAR OPENING} = \sqrt{((3.375")^2 + (22.5625" - 7.9375")^2)} = \underline{15.01"}$$

MINIMUM FRAME DIMENSION = 22.5625"

USA: 20" CLEAR OPENING

$$\text{CLEAR OPENING} = \sqrt{((3.375")^2 + (27.6875" - 7.9375")^2)} = \underline{20.03"}$$

MINIMUM FRAME DIMENSION = 27.6875"

$$\text{CLEAR OPENING} = \sqrt{((3.375)^2 + (\text{FRAME DIMENSION} - 7.9375)^2)}$$

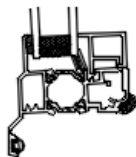

STARLINE WINDOWS IS NOT RESPONSIBLE FOR DETERMINING THE CLEAR OPENING IN ANY JURISDICTION.

Limitation of casements:

MIN HEIGHT = 15"	MIN WIDTH = 19"
MAX. HEIGHT = 60"	MAX. WIDTH = 30"
MAX. AREA = 10.0 SF	MAX. WEIGHT = 50 lbs
MAX. TORQUE LOAD = 50 POUND*FOOT	

Series 9000 Aluminum Window Wall Design Guidelines



60° Hinge Clear Opening Diagrams

Clear Openings Between Seismic Jamb

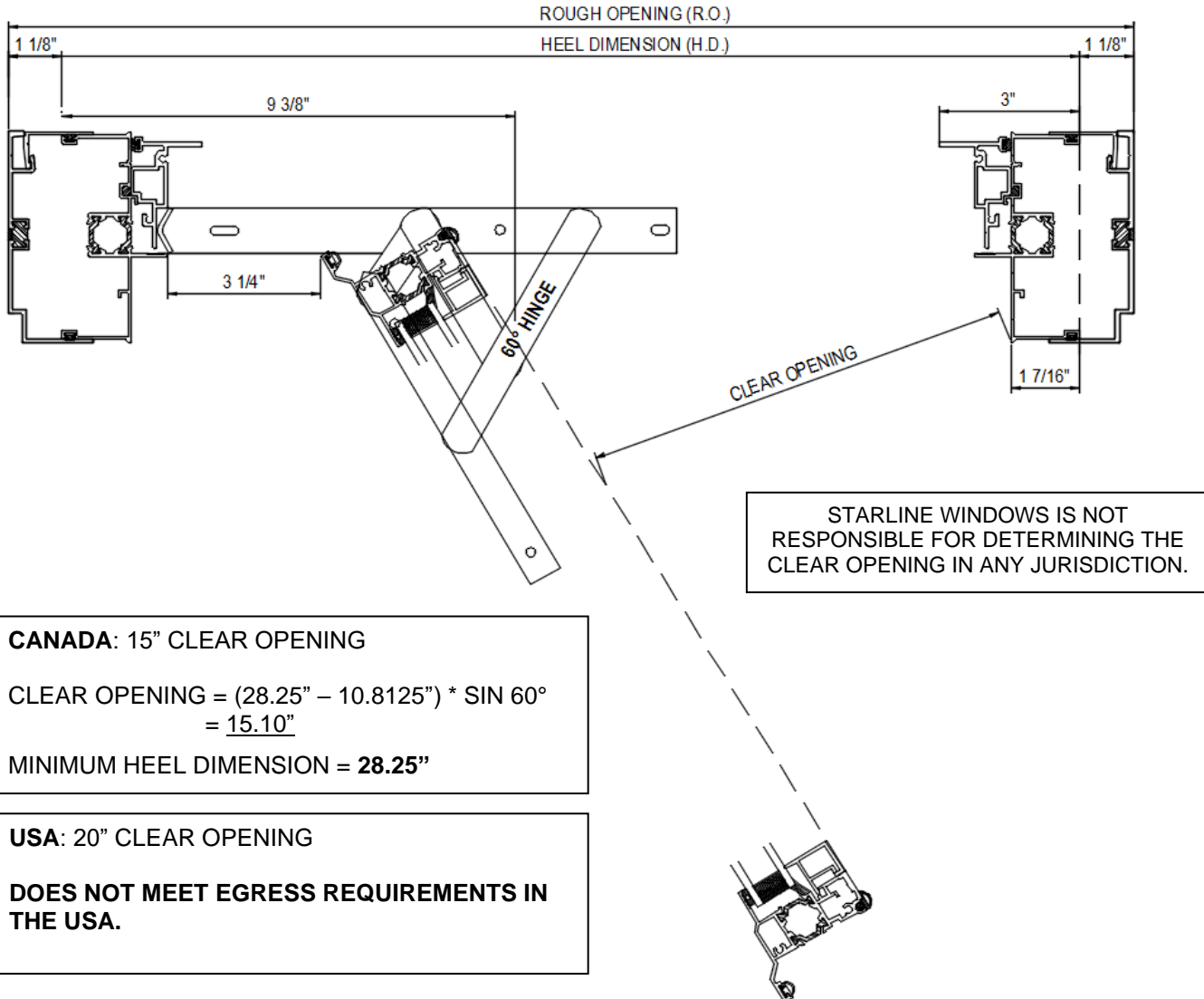

CLEAR OPENING = (FRAME DIMENSION – 10.8125") * SIN 60°

Limitation of casements:

- | | |
|---------------------|----------------------|
| MIN HEIGHT = 15" | MIN WIDTH = 15" |
| MAX. HEIGHT = 60" | MAX. WIDTH = 30" |
| MAX. AREA = 10.0 SF | MAX. WEIGHT = 50 lbs |

MAX. TORQUE LOAD = 50 POUND*FOOT

Clear Openings Between Seismic Jamb and Coupler

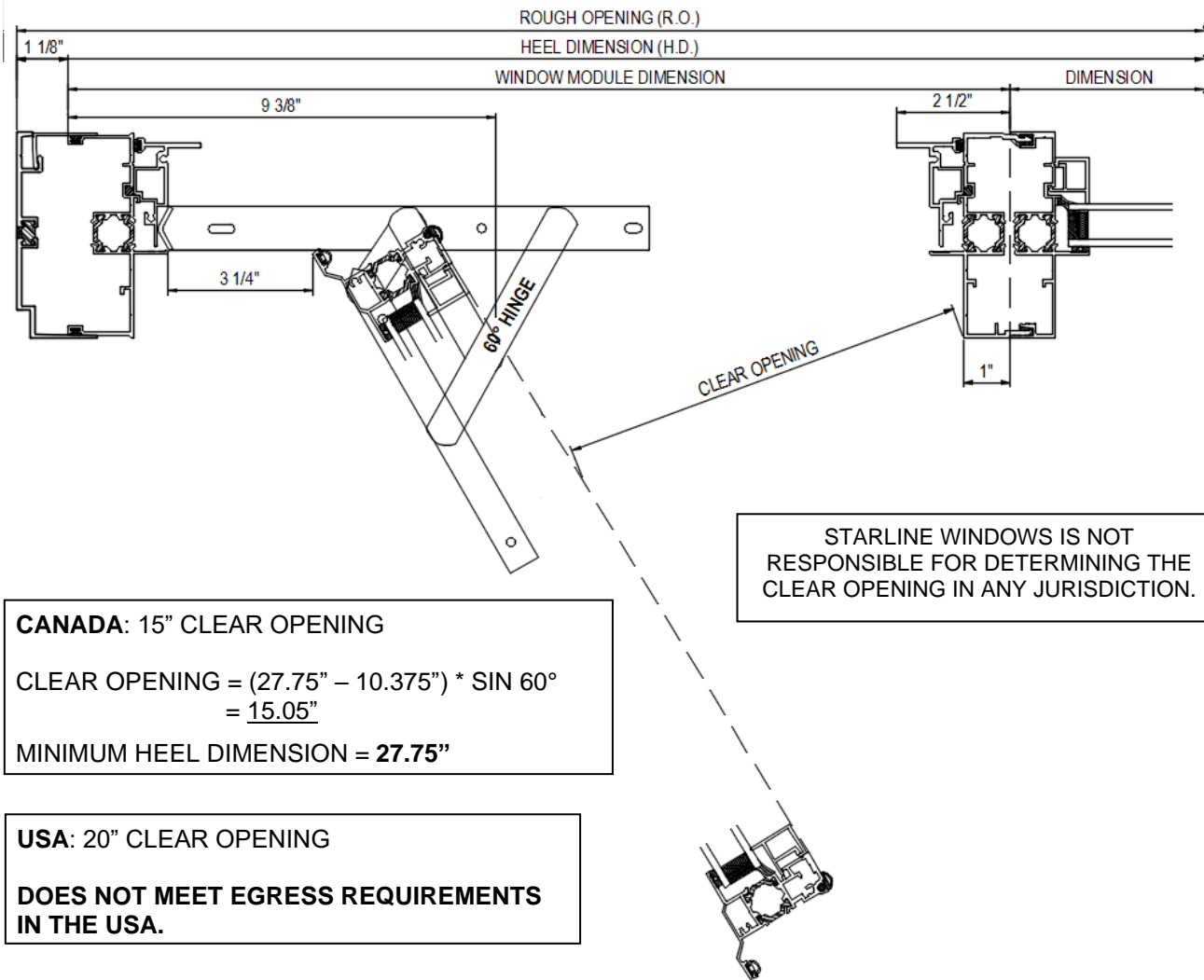

CLEAR OPENING = (FRAME DIMENSION – 10.375") * SIN 60°

Limitation of casements:

- | | |
|----------------------------------|----------------------|
| MIN HEIGHT = 15" | MIN WIDTH = 15" |
| MAX. HEIGHT = 60" | MAX. WIDTH = 30" |
| MAX. AREA = 10.0 SF | MAX. WEIGHT = 50 lbs |
| MAX. TORQUE LOAD = 50 POUND*FOOT | |

Series 9000 Aluminum Window Wall Design Guidelines



Clear Openings Between Couplers

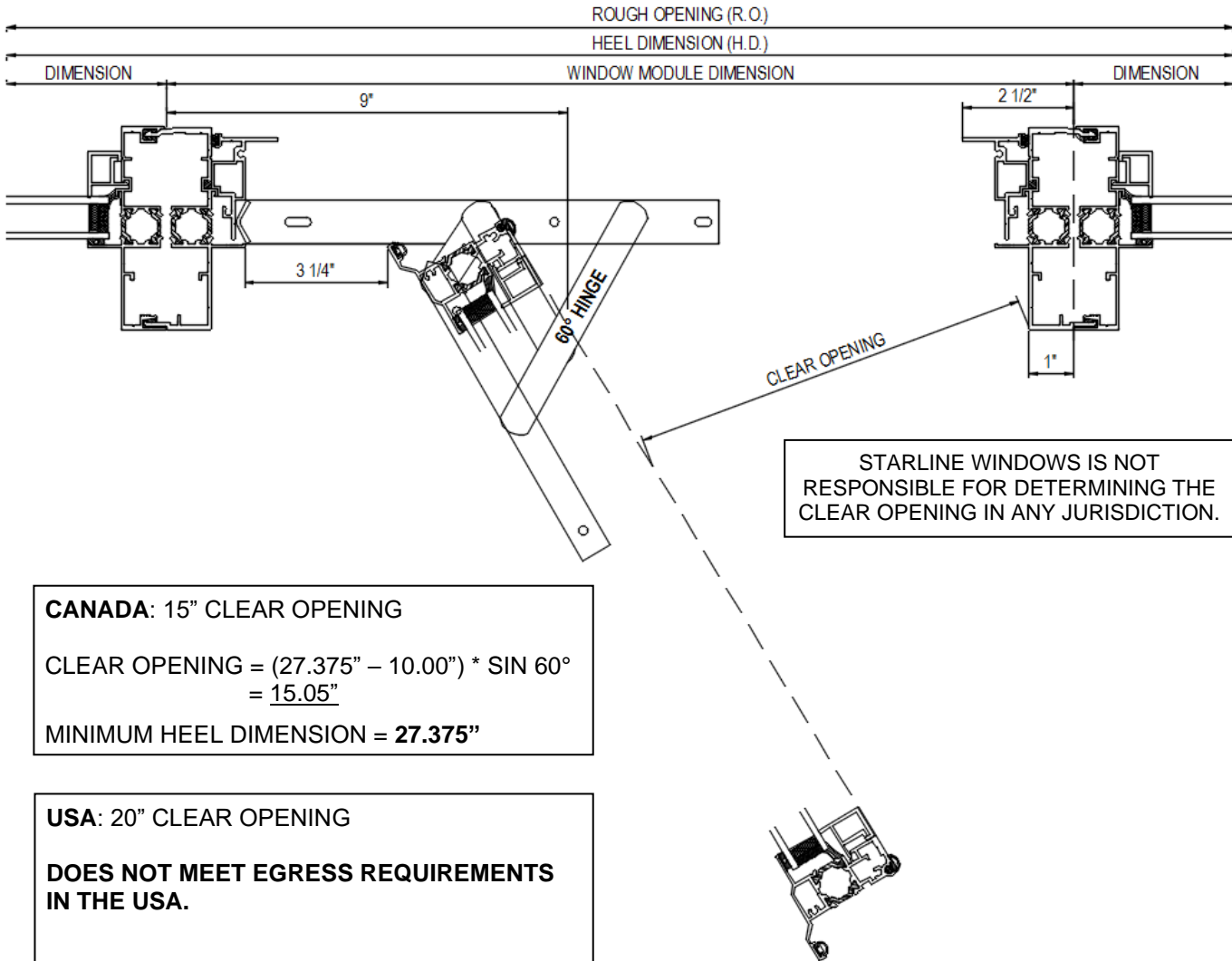

CANADA: 15" CLEAR OPENING

$$\text{CLEAR OPENING} = (27.375" - 10.00") * \text{SIN } 60^\circ = 15.05"$$

MINIMUM HEEL DIMENSION = **27.375"**

USA: 20" CLEAR OPENING

DOES NOT MEET EGRESS REQUIREMENTS IN THE USA.

$$\text{CLEAR OPENING} = (\text{FRAME DIMENSION} - 10.00") * \text{SIN } 60^\circ$$

Limitation of casements:

- | | |
|----------------------------------|----------------------|
| MIN HEIGHT = 15" | MIN WIDTH = 15" |
| MAX. HEIGHT = 60" | MAX. WIDTH = 30" |
| MAX. AREA = 10.0 SF | MAX. WEIGHT = 50 lbs |
| MAX. TORQUE LOAD = 50 POUND*FOOT | |

Product Specification 08 46 13 – Glazed Aluminum Window Wall



Note: Bolded text in this specification are options that are highlighted for the specifier to select or to list requirements.

Part 1 - General

A high-quality thermally broken 4 ½” aluminum window wall designed for residential high-rise construction.

1.1 Summary

A. Section Includes: Glazed Aluminum Window Wall:

1. Aluminum Window Wall system shall be Starline’s Series 9000 Window Wall manufactured by Starline Windows with seismic jambs, deflection header, **integral slab bypass** and **casement and/or awning operable vents**.
2. Work included: Furnish labor, material and other services to complete the fabrication and installation of the windows, including all materials and fitments required for the operation of the units in the manner, direction and performance shown on the shop drawings and specified herein.

Work not included: Structural support of window framing, interior trims. (**Specifier list others**).

Related work specified elsewhere: (**Specifier to list**).

B. Related Sections: (**Specifier to select the following related sections**)

1. 07 27 00 – Air Barriers
2. 07 60 00 – Flashing and Trim
3. 07 92 00 – Joint Sealants
4. 08 13 16 – Aluminum Doors (Outswing Aluminum Framed Glass Door)
5. 08 32 13 – Sliding Aluminum-Framed Glass Door
6. 08 44 13 – Glazed Aluminum Curtain Wall
7. 08 51 13 – Aluminum Windows
8. 08 80 00 – Glazing

Series 9000 Aluminum Window Wall Design Guidelines



1.2 Quality Assurance

- A. Drawings and specifications for Work of this Section are based upon the Series 9000 Window Wall manufactured by Starline Windows. Whenever alternative products are offered, submit supporting technical literature, samples, drawings and performance data for comparison 10 days prior to closing date. Test reports must be made available on request.
- B. Windows shall be tested and conform to the AAMA/WDMA/CSA 101 I.S.2/A440-08 and CSA A440SI-09 requirements.
- C. Manufacturer Qualifications:
 - 1. Manufacturer to have a minimum 10 years of documented experience.
 - 2. Manufacturer capable of providing an aluminum window system that meet or exceed the performance requirements indicated.
 - 3. Manufacturer capable of providing field representation during window installation.
- D. Installer Qualifications: Installer performing the Work in this Section to have a minimum of 3 years documented experience and approved by the manufacturer.
- E. Mock-Up: If requested by Consultant, a mock up is to be provided and installed at project site. Mock-up to include acceptable products and manufacturer approved installation methods. Obtain Owner's and Consultant's acceptance of finish colour, and workmanship standard.

1.3 Structural requirements

- A. Structural performance shall be based on CSA Standard CSA S157-17 "Strength Design in Aluminum".
- B. Limit mullion deflection to $L/175$.
- C. Allow for deflection of building structure. Aluminum window frames with a head deflection channel and seismic compensation channel shall be designed, fabricated and installed to withstand slab edge vertical differential deflections of maximum $3/4"$ ¹ and seismic inter-story lateral drift movements of elastic $\pm 3/4"$ ¹ without significant damage to the fenestration system or in-elastic $\pm 2 1/2"$ ¹ with significant damage expected but framing to be designed to remain anchored to the structure.

¹ Note to specifier: Values may change based on the configuration of the windows. Values to be specified by a Professional Engineer.

1.4 Test and Performance Requirements

Specifier to select from the following performance requirements.

- A. Fixed window wall shall meet performance class AW-PG60¹ when tested to AAMA/WDMA/CSA 101 I.S.2/A440-08 and CSA A440SI-09:
 - 1. Air Infiltration: Fixed window air infiltration shall not exceed 0.01 cfm/ft² (A3) when tested in accordance with ASTM E 283 with a pressure difference of 1.57 psf / 75 Pa.
 - 2. Water Penetration Resistance:
 - i. There shall be no water infiltration for fixed windows when tested in accordance with ASTM E547 with a pressure difference of 15.04 psf / 720 Pa (Laboratory Test).
 - ii. There shall be no water infiltration for fixed windows when tested in accordance with AAMA 502-08 with a pressure difference up to a maximum of 10.4 psf / 500 Pa (Field Test) ²

3. Uniform Load Deflection Test: The deflection of fixed window shall not exceed $L/175$ and there shall be no permanent set when tested in accordance with ASTM E330 with a design pressure of 60 psf / 2880 Pa, positive and negative.
 4. Uniform Load Structural Test: There shall be no damage to hardware, accessories, fasteners, or any other damage that would render the window in operable when tested in accordance with ASTM E330 with a structural test pressure of 90.1 psf / 4320 Pa, positive and negative.
 5. Forced Entry Resistance: Fixed window shall meet grade 20 when tested to ASTM F588.
 6. Thermal Performance³
 - i. U-value: The maximum fixed window thermal transmittance U-value shall be 0.32 BTU/ hr*ft²*°F (1.80 W/m²*k) when tested in accordance with AAMA 1503.1 and CAN/CSA-A440.2. Window shall be tested and labeled to N.F.R.C. standard 100 & 200.
 - ii. Solar Heat Gain Coefficient: A (**maximum or minimum**) of 0.33.
 - iii. Visible Light Transmittance: A (**maximum or minimum**) of 0.59.
- B. Operable windows (ventilator) shall meet performance class AW-PG60¹ when tested to AAMA/WDMA/CSA 101 I.S.2/A440-08 and CSA A440SI-09:
1. Air Infiltration: Operable window air infiltration shall not exceed 0.01 cfm/ft² (A3) when tested in accordance with ASTM E 283 with a pressure difference of 1.57 psf / 75 Pa.
 2. Water Penetration Resistance:
 - i. There shall be no water infiltration for operable windows when tested in accordance with ASTM E547 with a pressure difference of 15.04 psf / 720 Pa (Laboratory Test).
 - ii. There shall be no water infiltration for fixed windows when tested in accordance with AAMA 502-21 with a pressure difference up to a maximum of 10.4 psf / 500 Pa (Field Test)²
 3. Uniform Load Deflection Test: The deflection of operable window shall not exceed $L/175$ and there shall be no permanent set when tested in accordance with ASTM E330 with a design pressure of 60 psf / 2880 Pa, positive and negative.
 4. Uniform Load Structural Test: There shall be no damage to hardware, accessories, fasteners, or any other damage that would render the window inoperable when tested in accordance with ASTM E330 with a structural test pressure of 90.1 psf / 4320 Pa, positive and negative.
 5. Forced Entry Resistance: Operable window shall meet grade 20 when tested to ASTM F588.
 6. Operable windows shall meet performance criteria for Operating Force and Force to latch when tested to ASTM E2068.
 7. Thermal Performance³
 - i. U-value:
 - a. **Awning:** The maximum awning window thermal transmittance U-value shall be 0.41 BTU/ hr*ft²*°F (2.31 W/m²*k) when tested in accordance with AAMA 1503.1 and CAN/CSA-A440.2. Windows shall be tested and labeled to N.F.R.C. standard 100 & 200.
 - b. **Casement:** The maximum casement window thermal transmittance U-value shall be 0.41 BTU/ hr*ft²*°F (2.32 W/m²*k) when tested in accordance with AAMA 1503.1 and CAN/CSA-A440.2. Windows shall be tested and labeled to N.F.R.C. standard 100 & 200.
 - ii. Solar Heat Gain Coefficient:

Series 9000 Aluminum Window Wall Design Guidelines



- a. **Awning:** A maximum or minimum of 0.28.
- b. **Casement:** A maximum or minimum of 0.28.
- iii. Visible Light Transmittance:
 - a. **Awning:** A maximum or minimum of 0.47.
 - b. **Casement:** A maximum or minimum of 0.47.

¹ Note to specifier: Performance class result is based on lab testing and will vary by configuration and glass type. Contact Starline Windows for information on how the product can be engineered to achieve higher performance class than specified above.

² Note to specifier: 500Pa / 10.4 psf is the maximum field test result that can be achieved. Should the Project Specifications state a water penetration resistance field test pressure of a lesser value, the project specified values shall govern. The water penetration resistance field tests follow the criteria and testing procedures as outlined in the AAMA 502-21 specification standard.

³ Note to specifier: Thermal performance depends on glass specified. For double glazed values the above test was performed using 23mm double glazed insulated glass unit (6mm/Argon/4mm) with Standard high-performance soft coat (sputtered) Low E which is applied to surface #2, 90% argon + 10% air fill, with warm edge spacer bar. Please note: A second low E coating can be applied to surface #4 to further increase the thermal performance. The NFRC test sizes were 79" x 79" (2000mm x 2000mm) for a fixed window wall, 24" x 59" (600mm x 1500mm) for a casement window and 59" x 24" (1500mm x 600mm) for an awning window.

1.5 Submittals

- A. Product Data: Submit complete product data on system being used.
- B. Shop Drawings: Submit complete shop drawings which include floor plans, elevations, window schedule, and product components including anchorage, fasteners, accessories and finish colour.
- C. Samples: Submit glass and frame colour(s) samples.
- D. Close-out Submittals:
 - 1. Warranty: Submit executed Manufacturer's warranty which provides a guarantee for the complete installation provided under this section against defective material and workmanship which appears within a period of two years from the date of substantial completion.
 - 2. Project Record Documents: Submit operation and maintenance data for installed product in accordance with General Conditions

1.6 Project Conditions

- A. Field Measurements: Verify actual measurements / openings by field measurements prior to fabrication, until it is agreed upon in writing between the Window Manufacturer and the General Contractor that floors become "typical". Once typical the windows can be ordered off the previous field measurements.
- B. Indicate field measurements on shop drawings.

Part 2 – Products

2.1 Manufacturers

- A. Acceptable Manufacturers: Starline Windows
 - 1. Glazed Aluminum Window Wall: Series 9000
- B. Substitutions: Approved alternates

2.2 Material

- A. Aluminum Extrusion: 4 1/2" deep perimeter frame member. Frame member and intermediate bars are extruded from aluminum sections of 6063 alloy, T5 temper with a minimum thickness of 0.064".
- B. Fasteners: Stainless steel and of sufficient size and quantity to perform their intended function.
- C. Glazing Gaskets: Extruded Santoprene.
- D. Exterior Glazing Tape: Tremco Polyshim II
- E. Heel Bead: DOWSIL 1199
- F. Glass Setting Blocks & Edge Blocks: FPVC, Neoprene, EPDM, Santoprene or silicone with an 80 to 90 ± Shore A durometer hardness. Block material shall be compatible with sealed unit edge sealant. Setting blocks for sealed units with silicone edge seals must be silicone.
- G. Glazing bead: Extruded PVC and glazed from the interior.
- H. Thermal break: Polyamide.

2.3 Fabrication

- A. Fabricate framing from extrusions of size and shape shown on shop drawings.
- B. Interior and exterior extruded aluminum framing sections shall be integrated with a Polyamide thermal break to form a rigid composite assembly without the use of fasteners or other thermal bridging elements. Dry shrinkage of polyamide thermal break shall not exceed 0.10% of the framing member length.
- C. Main framing extrusions shall be butt corner construction.
- D. Operable sash (ventilator) extrusions shall be mitre corner construction.
- E. All framing profiles shall be straight and free of deformations and defects.
- F. Joints shall be accurately machined, fitted and sealed.
- G. Coupling mullions shall be designed to provide a functional split to permit modular construction and allow for thermal expansion.
- H. Perimeter frame shall be 4 1/2" deep with a minimum wall thickness of .064" (1.60mm) and be thermally broken.
- I. Operable window (ventilator) shall be 2 3/4" deep with a minimum wall thickness of .064" (1.60mm) and be thermally broken.
- J. All frame corners are mechanically joined by stainless steel screws.
- K. All interior joints and interior screw heads shall be sealed with a non-hardening sealant.
- L. Operable sash (ventilator) shall be double weather stripped with black santoprene bulb seal weather-stripping for the full perimeter at the interior and exterior of the ventilator.

Series 9000 Aluminum Window Wall Design Guidelines



- M. All glazing pockets shall be vented, pressure equalized, and drained to the outside.
- N. Glass bead shall be PVC and a snap-in screw less type.
- O. Silicone heel bead shall be applied at perimeter of insulated glass units.

2.4 Glazing¹

- A. Double glazed, double seal insulated glass unit with an overall thickness of 7/8" (23 mm). Triple glazed available (See [2.7.A.1](#) of this specification).
- B. Standard high performance soft coat (sputtered) Low E applied to surface #2.
- C. Black warm edge spacer with argon fill.
- D. Minimum glass thickness shall be 4mm. Glass thickness and quality shall conform to the requirements of the U.S.A. and Canadian Code for commercial construction, current edition.
- E. Where practical, glazing shall be installed at the factory before shipping to site.

¹ Note to specifier: Glazing noted above is based on Starline Windows standard product offering. There are various other options available. See [2.7.A.](#) of this specification.

2.5 Hardware¹

- A. Hardware for the aluminum operable sash (ventilator) and window frames shall be furnished by the window manufacturer.
- B. Where practical, all hardware fittings shall be installed at the factory before shipping to site.
- C. Hardware shall be as follows:
 - 1. Push out Operable sash (ventilator) shall be hung on concealed heavy duty stainless steel four bar friction hinges with adjustable friction shoe. Hinges are completely concealed when operable sash (ventilator) is in its closed position.
 - 2. Zinc-alloy cam handle shall lock positively against the mounted keeper. Handles are available in black and white.
 - 3. Mounted keeper is PVC and is available in black and white.
 - 4. 60° hinge restricted to 4".

¹ Note to specifier: Hardware noted above is based on Starline Windows standard product offering. There are various other options available. Refer to 2.7.L of this specification.

2.6 Finishes (Powder Coating)

- A. All exposed surfaces of aluminum door and framing members shall be free of scratches and other serious surface blemishes.
- B. Finishes¹.
 - 1. **Thermoset coating specifically designed for architectural systems. Coating to comply with AAMA 2603 specification and / or**
 - 2. **Upgrade to a thermoset super durable coating which complies with the AAMA 2604 specification standards. The AAMA 2604 standard demands advanced levels of weather resistance, gloss and colour retention, and corrosion resistance, among other increased standards when compared to the AAMA 2603 specification standard.**
 - 3. **Upgrade to a thermoset fluorocarbon coating which is a superior coating that complies with the AAMA 2605 specification standard. The AAMA 2605 standard demands advanced levels of weather resistance, gloss and colour retention, and corrosion resistance, among other increased standards when compared to the AAMA 2603 and AAMA 2604 specification standards.**
- C. Colour Options².
 - 1. Standard colours are as follows. (**Specifier to select from the standard colour(s) listed below**). These standard colours are **available in the AAMA 2603, AAMA 2604 and AAMA 2605 specification.**

White

Black

Brown

Silver

Charcoal Grey

¹ Note to Specifier: Select 2.6.B.1 and/or 2.6.B.2 and/or 2.6.B.3. Option to have dual frame colour and / or AAMA 2603 coating on interior and AAMA 2604 or AAMA 2605 coating on exterior is available, if standard and / or custom colour is selected. Refer to [2.7.K.1](#) of this specification. AAMA 2604 or AAMA 2605 specification standard on exterior of frames may be required in some building codes, bylaws, jurisdictions, etc.

² Note to Specifier: Refer to [2.7.K.2](#) of this specification for Custom Colours.

Series 9000 Aluminum Window Wall Design Guidelines



2.7 Optional Items

(Specifier to select from the following options)

- A. Glazing
 - 1. Triple glazed (Series 9203 Window Wall)
 - 2. Varying glass thickness available in 4mm or greater (**Specifier to select glass thickness required**).
 - 3. Tinted, obscured & reflective glass
 - 4. Spandrel glass
 - 5. Laminated glass
- B. Sandwich panels
- C. Coupling mullions – Wide range of couplers are available (all thermally broken) to suite a variety of configurations i.e.: 90°, 135°, 180°, etc.
- D. Bypass¹
 - 1. Spandrel glass on exterior / **Aluminum or galvanized** panel on interior.
 - i. ~R3 insulation at slab edge (DC6 standard detail)
 - ii. ~R6 insulation at slab edge (DC7 upgraded detail)
 - iii. In-slab Ducts
 - 2. Flush metal panel on the exterior / **Aluminum or galvanized** panel on interior.
 - i. ~R3 insulation at slab edge (DC6 standard detail)
 - ii. ~R6 insulation at slab edge (DC7 upgraded detail)
 - 3. Top Hat metal panel on exterior / **Aluminum or galvanized** panel on interior.
 - i. ~R3 insulation at slab edge (DC6 standard detail)
 - ii. ~R6 insulation at slab edge (DC7 upgraded detail)
 - iii. In-slab ducts
 - 4. Corrugated metal panel on exterior / Aluminum or galvanized panel on interior.
 - i. ~R3 insulation at slab edge (DC6 standard detail)
 - ii. ~R6 insulation at slab edge (DC7 upgraded detail)
 - 5. 1", 2", and/or 4" raised metal panel on exterior / **Aluminum or galvanized** panel on interior.
 - i. ~R3 insulation at slab edge (DC6 standard detail)
 - ii. ~R6 insulation at slab edge (DC7 upgraded detail)
 - iii. In-slab ducts *Not available for 1" raised metal panel.
 - 6. Spandrel glass IGU on exterior / **Aluminum or galvanized** panel on interior. (DC7 detail)
 - i. ~R6 insulation at slab edge (No low E coating)
 - ii. ~R7 insulation at slab edge (Spandrel IGU with standard low E on surface #2)
- E. Opaque areas other than Bypass
 - 1. Spandrel glass on exterior / **Aluminum or galvanized** panel on interior.

2. Flush metal panel on the exterior / **Aluminum or galvanized** panel on interior.
 3. Top Hat metal panel on exterior / **Aluminum or galvanized** panel on interior.
 4. Corrugated metal panel on exterior / Aluminum or galvanized panel on interior.
 5. 1", 2", and/or 4" raised metal panel on the exterior / **Aluminum or galvanized** panel on interior.
 6. Spandrel glass IGU on exterior / **Aluminum or galvanized** panel on interior.
- F. Transom Ducts
- G. Grille
- H. Climb deterrent
1. Fixed window climb deterrent
 2. Operable window climb deterrent
- I. Head trickle vent
- J. Stage anchor
- K. Finishes (Powder Coating)
1. Dual frame colour – 1 colour on exterior and 1 colour on interior (refer to [2.6.C](#) for colour options)
 - i. Finish to comply with AAMA 2603 standard on both interior and exterior.
 - ii. Finish to comply with AAMA 2604 standard on both interior and exterior.
 - iii. Finish to comply with AAMA 2605 standard on both interior and exterior.
 - iv. Finishes to comply with AAMA 2603 standard on interior and AAMA 2604 standard on exterior.
 - v. Finishes to comply with AAMA 2603 standard on interior and AAMA 2605 standard on exterior.
 2. **Custom colours**². Virtually any colour can be matched or very closely matched. The scope of work and overall custom colour quantity will be reviewed by Starline on a project specific basis to determine the feasibility of the custom colour request.
- L. Hardware:
1. Multi point locking hardware. The multi point handle is available in black and white. The multi points, not visible when window is in closed position, are available in black and white. When multipoint locks are selected, the minimum vent height for a casement is 22" but shall not exceed 60" in height. The minimum vent width is for an awning is 22" but shall not exceed 48" in width.
 2. Restrictor: Custodial
 3. 90° egress hinge.
- M. Extruded aluminum glazing bead (powder coated to match interior window colour).

¹ Note to Specifier: At the concrete bypass itself, there is no interior aluminum or galvanized panel.

² Note to Specifier: Custom colours are available for an additional cost premium. An approximate 12-week lead time is required to procure custom colour requests.

Series 9000 Aluminum Window Wall Design Guidelines



Part 3 - Execution

3.1 Examination

- A. Installer to examine openings, structural support, substrates and any other conditions that would affect the installation, for compliance with manufacturer's instructions.
- B. Verify rough opening dimensions.
- C. Verify sill is within tolerance of levelness to ensure adequate shimming to obtain proper drainage.

3.2 Installation

- A. Install manufacturer's system in accordance with manufacturer's approved shop drawings.
- B. Windows shall be installed and adjusted by experienced personnel in accordance with the manufacturer instructions and approved shop drawings.
- C. All items in this section shall be set in their correct location and shall be set level, square, plumb and at proper elevations and in alignment with other work.
- D. The windows are installed at site with a maximum variance to plumb of +/- 0.25%. (+/- 1/4" / 96").

3.3 Field Quality and Control

- A. Manufacturer's Field Services: Upon Owner and/or Consultants written request, provide manufacturer's field service representative for site visit to inspect installation and to ensure accordance with manufacturer's instruction and approved shop drawings.
- B. Field Tests: Owner and/or Consultant may choose to conduct tests for water penetration and air infiltration.
 - 1. Testing Standard per AAMA 502.
 - 2. Field testing shall be performed by a qualified independent testing agency.
 - 3. Field testing should not occur until the window has been installed and the caulking is cured. Ensure the products used to complete building envelope tie in (membrane, caulking, flashing, cladding, etc.) are installed complete and have cured.

3.4 Protection and Cleaning

- A. Protection:
 - 1. Windows shall be protected with blue poly during and after installation until acceptance by the General Contractor. Thereafter, it shall be the responsibility of the General Contractor to protect the installed product from construction damage.
 - 2. Windows shall be isolated from concrete, mortar, plaster and dissimilar metals with bituminous paint or other isolation coatings.
- B. Cleaning: It shall be the responsibility of the General Contractor to maintain protection and provide final cleaning.

Note: This specification is intended to be used by a qualified Specifier and will require modifications for the project specific requirements. This specification is not intended to be use verbatim as the project specific specification.

Laws, building and safety codes governing the design and use of this product vary widely. Starline Windows does not control the selection and use of this product and assumes no responsibility therefor.

Series 9000 NFRC Product Energy Chart

DOUBLE GLAZED (23mm IGU)	GLAZING (Exterior / Interior)	U VALUE (W/M ² K)	U VALUE (Btu/hft ² F)	Shading Coefficient	Solar Heat Gain Coefficient	Visible Light Transmittance	CPD (Certified Product Directory)
Center of Glass (COG)	6mm SB60 (#2) / 4mm Clear	1.41	0.25	0.44	0.39	0.71	
	6mm SB67* (#2) / 4mm Clear	1.41	0.25	0.33	0.29	0.54	
	6mm SN68 (#2) / 4mm Clear	1.42	0.25	0.43	0.37	0.68	
	6mm SN68 (#2) / 4mm IS20* (#4)	1.17	0.21	0.42	0.36	0.66	
	6mm SNR50* (#2) / 4mm Clear	1.40	0.25	0.28	0.25	0.48	
	6mm SNX51/23* (#2) / 4mm Clear	1.37	0.24	0.26	0.23	0.51	
	6mm SNX62/27* (#2) / 4mm Clear	1.37	0.24	0.30	0.26	0.62	
Fixed Window	6mm SB60 (#2) / 4mm Clear	1.79	0.32	0.39	0.34	0.61	STL-A-30-00590-00001
	6mm SB67* (#2) / 4mm Clear	1.79	0.32	0.29	0.25	0.47	
	6mm SN68 (#2) / 4mm Clear	1.80	0.32	0.37	0.33	0.59	STL-A-30-00611-00001
	6mm SN68 (#2) / 4mm IS20* (#4)	1.56	0.28	0.37	0.32	0.57	
	6mm SNR50* (#2) / 4mm Clear	1.78	0.31	0.25	0.22	0.42	
	6mm SNX51/23* (#2) / 4mm Clear	1.77	0.31	0.23	0.20	0.44	STL-A-30-00620-00001
	6mm SNX62/27* (#2) / 4mm Clear	1.76	0.31	0.26	0.23	0.53	STL-A-30-00617-00001
Awning	6mm SB60 (#2) / 4mm Clear	2.31	0.41	0.34	0.29	0.49	STL-A-26-00716-00001
	6mm SB67* (#2) / 4mm Clear	2.31	0.41	0.25	0.21	0.38	
	6mm SN68 (#2) / 4mm Clear	2.31	0.41	0.33	0.28	0.47	STL-A-26-00737-00001
	6mm SN68 (#2) / 4mm IS20* (#4)	2.14	0.38	0.31	0.27	0.46	
	6mm SNR50* (#2) / 4mm Clear	2.30	0.41	0.21	0.19	0.33	
	6mm SNX51/23* (#2) / 4mm Clear	2.29	0.40	0.20	0.17	0.35	STL-A-26-00746-00001
	6mm SNX62/27* (#2) / 4mm Clear	2.29	0.40	0.23	0.20	0.43	STL-A-26-00743-00001
Casement	6mm SB60 (#2) / 4mm Clear	2.32	0.41	0.34	0.29	0.49	STL-A-25-00716-00001
	6mm SB67* (#2) / 4mm Clear	2.32	0.41	0.24	0.21	0.38	
	6mm SN68 (#2) / 4mm Clear	2.32	0.41	0.33	0.28	0.47	STL-A-25-00737-00001
	6mm SN68 (#2) / 4mm IS20* (#4)	2.12	0.37	0.32	0.28	0.46	
	6mm SNR50* (#2) / 4mm Clear	2.31	0.41	0.21	0.19	0.33	
	6mm SNX51/23* (#2) / 4mm Clear	2.32	0.41	0.21	0.18	0.35	STL-A-25-00746-00001
	6mm SNX62/27* (#2) / 4mm Clear	2.31	0.41	0.24	0.21	0.43	STL-A-25-00743-00001
I.G.U. (Insulated Glass Unit)	GLASS			SPACER		GAS FILL	
	Guardian IS20*, SN68, SNR50*, SNX51/23*, SNX62/27*, Vitro SB60, SB67*			13.6mm (1/2") Warm Edge		90% Argon & 10% Air	

Based on NFRC CPD - Certification Date: April 2023 Expiration Date: November 2027

Fenestration = Frame, mullions, sash and vision glass. Refer to www.nfrc.org for more information.

* - Available at a cost premium.



Prepared by:
Kurt Leano
NFRC Certified Simulator